



# SECTION 17 POOL & SPA



PRODUCT LINE	PAGE
Pool Floats . . . . .	17.001
Rope & Float Kits . . . . .	17.002
Rope . . . . .	17.002A
Pool Rope Anchors & Hooks . . . . .	17.003
Unions - PVC Sch 80 . . . . .	17.004
Specialty Pool & Spa Fittings . . . . .	17.005
Pressure Gauges - Dry . . . . .	17.006
Pressure Gauges -NO LEAD Dry . . . . .	17.007
Pressure Gauges - Liquid Filled . . . . .	17.008
Pressure Gauges - NO LEAD Liquid . . . . .	17.008A
Test Kits & Specialty Gauges . . . . .	17.009
Gas Test Gauges, Flowmeters . . . . .	17.010
Ball Valves - PVC Single Union for Pool & Spa . . . . .	17.011
Valves - PVC Single Union, 3-way CPVC . . . . .	17.011A
Ball Valves - Economy PVC Molded-in-Place . . . . .	17.012
Ball Valves - PVC Sch 80 Molded-in-Place . . . . .	17.012A
Ball Valves - CPVC Sch 80 Molded-in-Place . . . . .	17.013
Slice Gate Valves - PVC . . . . .	17.014
Slice Gate Valves - PVC Swing . . . . .	17.015
Check Valves - PVC Spa, By-Pass . . . . .	17.016
Float Valves - Bronze, NO LEAD . . . . .	17.017
Butterfly Valves - Ductile Iron . . . . .	17.018
Butterfly Valve - Cast Iron . . . . .	17.018A
Butterfly Valves - PVC Sch 80 . . . . .	17.019
Flanges, Bolt Kits, Gaskets . . . . .	17.019A
Butterfly Valves - Installation Kits . . . . .	17.019B
Clear Braided PVC Hose . . . . .	17.020
Tubing - Polyethylene . . . . .	17.020B
Tubing - Clear Vinyl . . . . .	17.020C
Fittings for Plastic Tubing - NL Brass . . . . .	17.021
Pipe & Hose Cutters . . . . .	17.022
Pipe & Hose . . . . .	17.022B
PVC Pipe Cutters - Ratchet . . . . .	17.022C
PVC & ABS Saws and Hacksaws . . . . .	17.022D
Boss™ Pool & Spa Adhesives, Lubricants & Sealants . . . . .	17.023
Boss™ Expanding Foam Sealant . . . . .	17.023A
Installation & Repair . . . . .	17.024
Repair Fittings for Sch 40 Pipe . . . . .	17.026





# SECTION 17

# POOL & SPA



PRODUCT LINE	PAGE
Concrete Repair .....	17.027
Equipment Pads .....	17.028
Pool Service Accessories .....	17.029
Pool Service Tools - Multipurpose Tools .....	17.029A
Pool Service Tools - Anchor, Shell Extractor Kits .....	17.029B
Pool Service Tools - Multipurpose Keys .....	17.029C
Pool Service Tools - Service Kits .....	17.029D
Pool Service Tools - Accessories .....	17.029E
Winterizing Plugs .....	17.030
Winteriing Accessories .....	17.030A
Pool Cover & Utility Pumps .....	17.031





IF Series

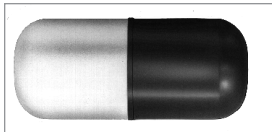

HF Series



RBF Series

### HARVARD Handi-Lock® Float Features:

- Made of polyethylene and treated with chlorine inhibitors and ultraviolet stabilizers for durability and long life.
- Self locking feature fixes on line without additional expense of float keepers or wedges.
- Three sealed compartments for optimum buoyancy in case of puncture.
- Three inside diameters to accommodate 3/8", 1/2" or 3/4" rope (either hollow braid or twisted).
- Patented.



### HARVARD High Impact Styrene Float Features:

- Blue and white high impact styrene.
- Fits 3/8" hollow braid rope.



### HARVARD Rainbow Style Float Features:

- 3" x 5" for 1/2" pool rope and 5" x 9" for 3/4" pool rope available.

Part Number	Float Size	Rope Size	Color	Ctn Qty
IF3538	3" x 5"	3/8"	Blue/White/Blue	50
IF3538R	3" x 5"	3/8"	Red/White/Red	50
IF3538O	3" x 5"	3/8"	Orange/White/Orange	50
IF3550	3" x 5"	1/2"	Blue/White/Blue	50
IF3550R	3" x 5"	1/2"	Red/White/Red	50
IF3550O	3" x 5"	1/2"	Orange/White/ Orange	50
IF3550RWB	3" x 5"	1/2"	Red/White/Blue	50
IF3550 ALL BLUE	3" x 5"	1/2"	Blue/Blue/Blue	50
IF3550 ALL RED	3" x 5"	1/2"	Red/Red/Red	50
IF3550 ALL WHITE	3" x 5"	1/2"	White/White/White	50
IF5950	5" x 9"	1/2"	Blue/White/Blue	24
IF5950R	5" x 9"	1/2"	Red/White/Red	24
IF5950O	5" x 9"	1/2"	Orange/White/Orange	24
IF5950W	5" x 9"	1/2"	White/White/White	24
IF5975	5" x 9"	3/4"	Blue/White/Blue	24
IF5975R	5" x 9"	3/4"	Red/White/Red	24
IF5975O	5" x 9"	3/4"	Orange/ White/Orange	24
IF5975RWB	5" x 9"	3/4"	Red/White/Blue	24
HF35	3" x 5"	3/8"	Blue/White	10
RBF35BW	3" x 5"	1/2"	Blue/White	100
RBF35RW	3" x 5"	1/2"	Red/White	100
RBF35YW	3" x 5"	1/2"	Yellow/White	100
RBF35W	3" x 5"	1/2"	Solid White	100
RBF59BW	5" x 9"	3/4"	Blue/White	24
RBF59RW	5" x 9"	3/4"	Red/White	24
RBF59YW	5" x 9"	3/4"	Yellow/White	24
RBF59WHITE	5" x 9"	3/4"	Solid White	24
RBF59RED	5" x 9"	3/4"	Solid Red	24



# Pool Rope and Float Kits



IFK Series

### IFK Series Float Kit Features:

- Blue and White Handi-Lock® Floats packaged for 16', 18', 20', 22' and 25' pools.
- Each partially assembled kit contains rope, Handi-Lock® Floats, 2 chrome plated brass rope hooks, splicing FID, and a full set of illustrated instructions.
- Individually packaged in shelf stackable boxes.
- 4 kits per master carton.



RFK Series

### RFK Series Float Kit Features:

- Blue and White styrene float lane markers packaged for 12', 14', 16', 18', 20', 22' and 25' pools.
- Completely assembled and ready to install.
- Each individually bagged kit contains braided polypropylene rope with attractive blue/white floats, prefixed at regular intervals and two chrome plated brass hook eyes.

Part Number	Pool Size	Rope Length	Rope Size	Floats	Ctn Qty
IFK16	16'	18'	3/8"	5	4
IFK18	18'	20'	3/8"	6	4
IFK20	20'	22'	3/8"	7	4
IFK22	22'	24'	3/8"	7	4
IFK25	25'	27'	3/8"	8	4
RFK12	12'	14'	3/8"	5	6
RFK14	14'	16'	3/8"	5	6
RFK16	16'	18'	3/8"	5	6
RFK18	18'	20'	3/8"	7	6
RFK20	20'	22'	3/8"	9	4
RFK22	22'	24'	3/8"	9	4
RFK25	25'	27'	3/8"	10	4

Custom Float Kits also available on a special order basis.



[www.cb-supplies.ca](http://www.cb-supplies.ca)  
 Phone: (866) 503-5523 Fax: (888) 562-2095  
 AGI@cbsupplies.ca







# Pool Rope and Float Kits



PR Series

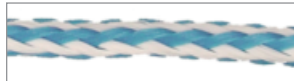

BPR Series

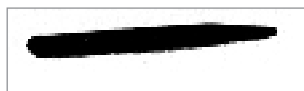

FID

## Pool Rope Features:

- Polypropylene.
- Floatable.
- Waterproof.
- Rot Resistant.
- Easy to Handle.
- Resists Oil and Gasoline.
- Resists Most Chemicals.
- Resistant to Abrasion.
- Resistant to Color Fading.

Part Number	Color	Diameter	Length
<b>Twisted Pool Rope</b>			
YR25-500	Solid Yellow	1/4"	500'
PR25-6	Blue/White	1/4"	600'
PR25-6R	Red/White	1/4"	600'
YR25-1	Solid Yellow	1/4"	1000'
PR38-3R	Red/White	3/8"	300'
PR38-3O	Orange/White	3/8"	300'
PR38-3W	Solid White	3/8"	300'
PR38-4	Blue/White	3/8"	400'
PR38-6	Blue/White	3/8"	600'
PR38-6R	Red/White	3/8"	600'
PR38-6O	Orange/White	3/8"	600'
PR38-6W	Solid White	3/8"	600'
PR50-3	Blue/White	1/2"	300'
PR50-3R	Red/White	1/2"	300'
PR50-3O	Orange/White	1/2"	300'
PR50-3W	Solid White	1/2"	300'
PR50-6	Blue/White	1/2"	600'
PR50-6R	Red/White	1/2"	600'
PR50-6O	Orange/White	1/2"	600'
PR50-6W	Solid White	1/2"	600'
PR58-6	Blue/White	5/8"	600'
PR75-3	Blue/White	3/4"	300'
PR75-3R	Red/White	3/4"	300'
PR75-3O	Orange/White	3/4"	300'
PR75-3W	Solid White	3/4"	300'
PR75-6	Blue/White	3/4"	600'
PR75-6R	Red/White	3/4"	600'
PR75-6O	Orange/White	3/4"	600'
PR75-6W	Solid White	3/4"	600'
PR75-6Y	Solid Yellow	3/4"	600'
<b>Braided Pool Rope</b>			
BPR38-5	Blue/White	3/8"	500'
<b>Splicing Fid</b>			
FID	Splicing Fid, For 3/8" braided rope		



# Pool Rope Anchors & Hooks

## Chrome Plated Brass Rope Accessory Features:

- Bright chrome finished brass rope accessories.
- Precision cast from corrosion resistant brass.
- Stainless steel fasteners.
- Black or White EPDM gaskets.
- Fully assembled.

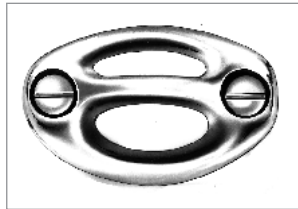

HOE2

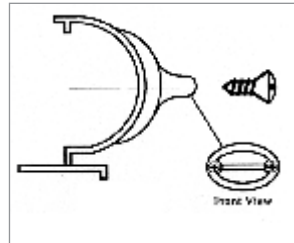

HOE2

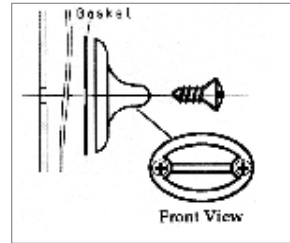

HOE2F

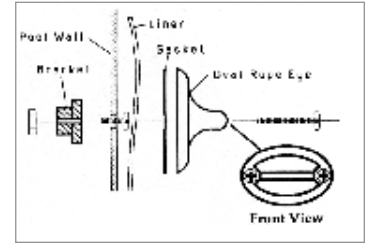

HOE2FB



HCA



HEBA



HPRS



HRH



AGHP

Part Number	Description	Ctn Qty
HOE2	Chrome Plated Brass CURVED COPING MOUNT Oval Rope Anchor (Set of 2 w/ ss self tap screws)	72
HOE2F	Chrome Plated Brass FLAT WALL MOUNT Oval Rope Anchor (Set of 2 w/ ss self tap screws, EPDM gasket)	6/72
HOE2FB	Chrome Plated Brass FLAT WALL MOUNT Oval Rope Anchor w/ brass mounting bracket and hardware (Set of 2 w/ ss screws, EPDM gasket, brass mounting brackets)	6/72
HCA	Chrome Plated Brass Cup Anchor for concrete pools.	12/120
HEBA	Chrome Plated Brass wall mount eye with washer gasket and nut for vinyl liners. 1-3/8" long bolt	20/200
HPRS	Chrome Plated Strap Type Rope Anchor used under coping for vinyl pools. 14" long	12/252
HRH	Chrome Plated Brass "S" Rope Hook for 1/4"-1/2" rope	500
AGHP52	CLEAT Style Chrome Plated Brass Hook for 3/8" & 1/2" rope w/ ss screws	125
AGHP53	CLEAT Style Chrome Plated Brass Hook for 3/4" rope w/ ss screws	125



# Unions - PVC Sch 80



PV79, PV69 Series

**ISO 9002**



## PVC Sch 80 Union Features:

- Ideal for swimming pool, spa and plumbing installations.
- EPDM O-Ring seal.
- Working pressure: 150 PSI at 72°F, 100 PSI at 120°F.
- Meets ASTM standards for Schedule 80 construction.
- Manufactured for AGI in an ISO 9002 facility.
- NSF listed.
- Available white or gray.
- **Third party certified to NSF/ANSI 372.**

MATERIAL SPECIFICATIONS	
Body	PVC
End Connector	PVC
Union Nut	PVC
O-Ring	EPDM

DIMENSIONS (IN.)	SIZE	d3	D1	D2	L
	1/2"	.51	1.21	1.80	2.11
	3/4"	.71	1.45	2.15	2.42
	1"	.92	1.76	2.58	2.69
	1 1/4"	1.17	2.11	3.20	3.32
	1 1/2"	1.52	2.54	3.83	3.40
	2"	1.92	3.05	4.68	3.71
	3"	2.84	3.52	6.10	4.96
	4"	3.94	4.52	8.86	6.30

Part Number		IPS Size	Ctn Qty	List Price		
<b>SCHEDULE 80 - WHITE</b>				<b>PV797</b>	<b>PV798</b>	<b>PV799</b>
<b>SLIP X SLIP</b>	<b>FIPT X FIPT</b>	<b>SLIP X FIPT</b>		<b>SXS</b>	<b>TXT</b>	<b>SXT</b>
PV797-1/2	PV798-1/2	1/2"	36			
PV797-3/4	PV798-3/4	3/4"	24/144			
PV797-1	PV798-1	1"	12/96			
PV797-1 1/4	PV798-1 1/4	1 1/4"	12/96			
PV797-1 1/2	PV798-1 1/2	PV799-1 1/2	8/64			
PV797-2	PV798-2	PV799-2	4/48			
<b>SCHEDULE 80 - GRAY</b>				<b>PV697</b>	<b>PV698</b>	
<b>slip x slip</b>	<b>FIPT x FIPT</b>			<b>SxS</b>	<b>TXT</b>	
PV697-1/2	PV698-1/2	1/2"	36/288			
PV697-3/4	PV698-3/4	3/4"	24/144			
PV697-1	PV698-1	1"	12/96			
PV697-1 1/4	PV698-1 1/4	1 1/4"	12/96			
PV697-1 1/2	PV698-1 1/2	1 1/2"	8/64			
PV697-2	PV698-2	2"	4/48			
PV697-3	PV698-3	3"	2/12			
PV697-4		4"	1/4			
<b>Replacement O-Ring for PV797, PV798, PV799, PV697, PV698</b>						
PV796-1/2		1/2"	1			
PV796-3/4		3/4"	1			
PV796-1		1"	1			
PV796-1 1/4		1 1/4"	1			
PV796-1 1/2		1 1/2"	1			
PV796-2		2"	1			
<b>Union Repair Split Nut</b>						
SNR150		1 1/2" FBT Repair Split Nut w/ Screw	125			
SNR200		2" FBT REpair Split Nut w/ Screw	100			



# Specialty Pool & Spa Fittings

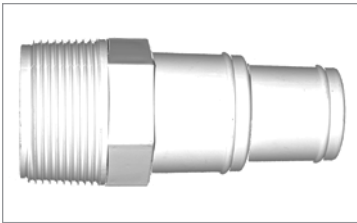

SPA1512

### Pool/Spa Hose Adapter Features:

- Larger hex nut than most other styles
- Ribbed insert end to promote a tight seal and tapered thread to prevent “bottoming out” during installation
- White ABS plastic

Part Number	Description	Ctn Qty	List Price
SPA1512	1 1/2" mip x 1 1/2", 1 1/4" combo hose adapter	100	\$ 1.86

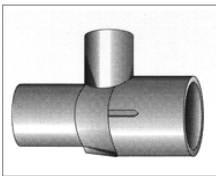

473-210

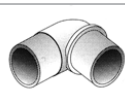

B1241

Part Number	Description	Ctn Qty	List Price
<b>Venturi Tee</b>			
473-825	3/4" x 1" x 3/4" Venturi Tee	50	\$ 12.37
473-210	1 1/2" x 1 1/2" x 3/4" Venturi Tee	25	15.05
<b>Fittings</b>			
B1241-00	1 1/2" 90 elbow, spigot x spigot	25	11.00



SW406 Series



SW409 Series

### PVC Sweep Elbow Features:

- Exceeds requirements of CA Title 24, Pool Systems & Equipment Installations.
- Sweep Elbows reduce head loss.
- Socket dimensions to Sch 40 ASTM D 2464.
- Listed to NSF/ANSI Standard 50 Swimming Pools, Spas and Hot Tubs - Circulation System Component.

Part Number	Description	Ctn Qty	List Price
SW406-015	1 1/2" PVC Sweep Elbow SL x SL	25	\$ 3.87
SW406-020	2" PVC Sweep Elbow SL x SL	25	4.61
SW406-025	2 1/2" PVC Sweep Elbow SL x SL	25	7.39
SW409-015	1 1/2" PVC Sweep Elbow SL x SPG	25	3.67
SW409-020	2" PVC Sweep Elbow SL x SPG	25	4.38



### Schedule 80 CPVC Nipple Features:

- Sturdy.
- Lightweight.
- Chemical Resistant.
- Gray.
- Threaded on both ends.

SCHEDULE 80 CPVC PIPE NIPPLES			
PART NO.	SIZE	CTN QTY	LIST PRICE
CPVC1XCLOSE	1 X CLOSE	25	\$ 2.92
CPVC11/2XCLOSE	1 1/2 x CLOSE	25	4.26
CPVC11/2X6	1 1/2X 6	25	12.27
CPVC11/2x8	1 1/2 x 8	25	14.92
CPVC11/2X12	1 1/2 X 12	25	23.24
CPVC2XCLOSE	2 X CLOSE	25	7.10
CPVC2X6	2 X 6	25	17.50
CPVC2x8	2 x 8	25	20.73
CPVC2X12	2 X 12	BULK	31.94
CPVC2x24	2 x 24	BULK	64.26



# Pressure Gauges - Dry



Pressure Gauge

**ISO 9001**

## Pressure Gauge Features:

- Rugged precision made phosphor-bronze Bourdon tube movements assuring maximum accuracy (+/- 3-2-3%) under adverse field conditions.
- **TO BE USED WITH AIR OR WATER ONLY.**
- Manufactured for AGI in an ISO 9001 facility.



## POLYPROPYLENE CASE:

- Bourdon tube movement is totally enclosed in corrosion resistant polypropylene housing, acrylic lens.
- Resists rust, electrolytic action and chemical solvents.
- Brass sockets standard.

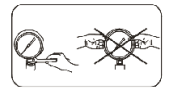

CAUTION

## STEEL CASE:

- Deep drawn one piece steel housing encases a quality movement.
- Genuine mar-resistant glass lens and brass socket connections are standard.

Part Number	Case	Range	Type	Dial Size	MIP Conn.	Ctn Qty
<b>2" DIAL SIZE, PLASTIC CASE, DRY</b>						
IPPG302-4L	Plastic	0-30#	Pressure	2"	1/4 Lower	100
IPPG302-4B	Plastic	0-30#	Pressure	2"	1/4 Back	100
IPPG602-4L	Plastic	0-60#	Pressure	2"	1/4 Lower	100
IPPG602-4B	Plastic	0-60#	Pressure	2"	1/4 Back	100
IPPG1002-4L	Plastic	0-100#	Pressure	2"	1/4 Lower	100
IPVG302-4L	Plastic	0-30 Hg"	Vacuum	2"	1/4 Lower	100
<b>2" DIAL SIZE, STEEL CASE, DRY</b>						
IPG152-4L	Steel	0-15#	Pressure	2"	1/4 Lower	100
IPG302-4L	Steel	0-30#	Pressure	2"	1/4 Lower	100
IPG302-4B	Steel	0-30#	Pressure	2"	1/4 Back	100
IPG302-8L	Steel	0-30#	Pressure	2"	1/8 Lower	100
IPG302-8B	Steel	0-30#	Pressure	2"	1/8 Back	100
IPG602-4L	Steel	0-60#	Pressure	2"	1/4 Lower	100
IPG602-4B	Steel	0-60#	Pressure	2"	1/4 Back	100
IPG602-8L	Steel	0-60#	Pressure	2"	1/8 Lower	100
IPG1002-4L	Steel	0-100#	Pressure	2"	1/4 Lower	100
IPG1002-4B	Steel	0-100#	Pressure	2"	1/4 Back	100
IPG1002-8B	Steel	0-100#	Pressure	2"	1/8 Back	100





# Pressure Gauges - Dry

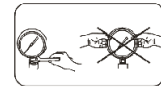

CAUTION



CAUTION  
DO NOT USE WITH  
POTABLE WATER

↓ Reduced price - Limited quantities available.

Part Number	Case	Range	Type	Dial Size	MIP Conn.	Ctn Qty
<b>2" DIAL SIZE, STEEL CASE, DRY</b>						
IPVG302-4B	Steel	0-30 Hg"	Vacuum	2"	1/4 Back	100
IPVG302-8L	Steel	0-30 Hg"	Vacuum	2"	1/8 Lower	100
IPCG3602-4L	Steel	30Hg"/60#	Vacuum/PResure	2"	1/4 Lower	200
<b>2 1/2" DIAL SIZE, DRY</b>						
IPG3025-4L	Steel	0-30#	Pressure	2 1/2"	1/4 Lower	100
IPG6025-4L	Steel	0-60#	Pressure	2 1/2"	1/4 Lower	100
IPG10025-4L	Steel	0-100#	Pressure	2 1/2"	1/4 Lower	50
IPG16025-4L	Steel	0-160#	Pressure	2 1/2"	1/4 Lower	100
IPG40025-4L	Steel	0-400#	Pressure	2 1/2"	1/4 Lower	50
IPVG3025-4L	Plastic	0-30 Hg"	Vacuum	2 1/2"	1/4 Lower	50
IPCG31025-4L	Steel	30 Hg"/160#	Vacuum/Pressure	2 1/2"	1/4 Lower	50
<b>4 1/2" DIAL SIZE, STEEL CASE, DRY</b>						
IPG3045-4L	Steel	0-30#	Pressure	4 1/2"	1/4 Lower	50
IPG6045-4L	Steel	0-60#	Pressure	4 1/2"	1/4 Lower	50
IPG10045-4L	Steel	0-100#	Pressure	4 1/2"	1/4 Lower	50
IPG30045-4L	Steel	0-300#	Pressure	4 1/2"	1/4 Lower	50
IPVG3045-4L	Steel	30 Hg"	Vacuum	4 1/2"	1/4 Lower	50
IPCG36045-4L	Steel	30 Hg"/60#	Vacuum/Pressure	4 1/2"	1/4 Lower	50
IPCG31045-4L	Steel	30 Hg"/160#	Vacuum/Pressure	4 1/2"	1/4 Lower	50



[www.cb-supplies.ca](http://www.cb-supplies.ca)  
 Phone: (866) 503-5523 Fax: (888) 562-2095  
[AGI@cb-supplies.ca](mailto:AGI@cb-supplies.ca)



17.006A



# Pressure Gauges - No Lead Dry



IPPG or IPG Series

**ISO 9001**

## Pressure Gauge Features:

- Rugged precision made phosphor-bronze Bourdon tube movements assuring maximum accuracy (+/- 3-2-3%) under adverse field conditions.
- **TO BE USED WITH AIR OR WATER ONLY.**
- Manufactured for AGI in an ISO 9001 facility.
- Bourdon tube movement is totally enclosed in corrosion resistant housing.
- Resists rust, electrolytic action and chemical solvents.
- **Third party certified to NSF/ANSI 372.** No Lead brass sockets.
- Deep drawn one piece steel or molded plastic housings encase a quality movement.
- Genuine mar-resistant glass or acrylic lens.

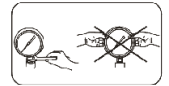

Part Number	Case	Range	Type	Dial Size	MIP Conn.	Ctn Qty
<b>2" DIAL SIZE, PLASTIC CASE, DRY</b>						
IPPG302-4LNL	Plastic	0-30#	Pressure	2"	1/4 Lower	100
IPPG302-4BNL	Plastic	0-30#	Pressure	2"	1/4 Back	100
IPPG602-4LNL	Plastic	0-60#	Pressure	2"	1/4 Lower	100
IPPG602-4BNL	Plastic	0-60#	Pressure	2"	1/4 Back	100
IPPG1002-4LNL	Plastic	0-100#	Pressure	2"	1/4 Lower	100
EIPPG1002-4LPNL	Plastic	0-100#	Pressure	2" No dial logo	1/4 Lower	100
IPPG1002-4BNL	Plastic	0-100#	Pressure	2"	1/4 Back	100
IPVG302-4LNL	Plastic	0-30 Hg"	Vacuum	2"	1/4 Lower	100
<b>2" DIAL SIZE, STEEL CASE, DRY</b>						
IPG152-4LNL	Steel	0-15#	Pressure	2"	1/4 Lower	100
IPG302-4LNL	Steel	0-30#	Pressure	2"	1/4 Lower	100
IPG302-4BNL	Steel	0-30#	Pressure	2"	1/4 Back	100
IPG302-8LNL	Steel	0-30#	Pressure	2"	1/8 Lower	100
IPG302-8BNL	Steel	0-30#	Pressure	2"	1/8 Back	100
IPG602-4LNL	Steel	0-60#	Pressure	2"	1/4 Lower	100
IPG602-4BNL	Steel	0-60#	Pressure	2"	1/4 Back	100
IPG602-8LNL	Steel	0-60#	Pressure	2"	1/8 Lower	100
IPG1002-4LNL	Steel	0-100#	Pressure	2"	1/4 Lower	100
EIPG1002-4LPNL	Steel	0-100#	Pressure	2" No dial logo	1/4 Lower	100
IPG1002-4BNL	Steel	0-100#	Pressure	2"	1/4 Back	100
IPG1002-8LNL	Steel	0-100#	Pressure	2"	1/8 Lower	100
IPG1002-8BNL	Steel	0-100#	Pressure	2"	1/8 Back	100
IPG1602-4LNL	Steel	0-160#	Pressure	2"	1/4 Lower	100





# Pressure Gauges - No Lead Dry

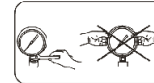

CAUTION



Part Number	Case	Range	Type	Dial Size	MIP Conn.	Ctn Qty
<b>2" DIAL SIZE, STEEL CASE, DRY</b>						
IPG2002-4LNL	Steel	0-200#	Pressure	2"	1/4 Lower	100
IPG2002-4BNL	Steel	0-200#	Pressure	2"	1/4 Back	100
IPG2002-8LNL	Steel	0-200#	Pressure	2"	1/8 Lower	100
IPG3002-4LNL	Steel	0-300#	Pressure	2"	1/4 Lower	100
IPVG302-4BNL	Steel	0-30 Hg"	Vacuum	2"	1/4 Back	100
IPVG302-8LNL	Steel	0-30 Hg"	Vacuum	2"	1/8 Lower	100
IPCG3102-4LNL	Steel	30 Hg"/160#	Vacuum/Pressure	2"	1/4 Lower	100
IPCG3602-4LNL	Steel	30Hg"/60#	Vacuum/PResure	2"	1/4 Lower	200
<b>2 1/2" DIAL SIZE, DRY</b>						
IPG1525-4LNL	Plastic	0-15#	Pressure	2 1/2"	1/4 Lower	100
IPG3025-4LNL	Steel	0-30#	Pressure	2 1/2"	1/4 Lower	100
IPG6025-4LNL	Steel	0-60#	Pressure	2 1/2"	1/4 Lower	100
IPG10025-4LNL	Steel	0-100#	Pressure	2 1/2"	1/4 Lower	50
IPG16025-4LNL	Steel	0-160#	Pressure	2 1/2"	1/4 Lower	100
IPG20025-4LNL	Steel	0-200#	Pressure	2 1/2"	1/4 Lower	100
IPG30025-4LNL	Steel	0-300#	Pressure	2 1/2"	1/4 Lower	50
IPG40025-4LNL	Steel	0-400#	Pressure	2 1/2"	1/4 Lower	50
IPVG3025-4LNL	Plastic	0-30 Hg"	Vacuum	2 1/2"	1/4 Lower	50
IPCG31025-4LNL	Steel	30 Hg"/160#	Vacuum/Pressure	2 1/2"	1/4 Lower	50
<b>3 1/2" DIAL SIZE, STEEL CASE, DRY</b>						
IPG3035-4LNL	Steel	0-30#	Pressure	3 1/2"	1/4 Lower	50
IPG10035-4LNL	Steel	0-100#	Pressure	3 1/2"	1/4 Lower	50
IPG20035-4LNL	Steel	0-200#	Pressure	3 1/2"	1/4 Lower	50
IPG30035-4LNL	Steel	0-300#	Pressure	3 1/2"	1/4 Lower	50
<b>4 1/2" DIAL SIZE, STEEL CASE, DRY</b>						
IPG3045-4LNL	Steel	0-30#	Pressure	4 1/2"	1/4 Lower	50
IPG6045-4LNL	Steel	0-60#	Pressure	4 1/2"	1/4 Lower	50
IPG10045-4LNL	Steel	0-100#	Pressure	4 1/2"	1/4 Lower	50
IPG20045-4LNL	Steel	0-200#	Pressure	4 1/2"	1/4 Lower	50
IPG30045-4LNL	Steel	0-300#	Pressure	4 1/2"	1/4 Lower	50
IPVG3045-4LNL	Steel	30 Hg"	Vacuum	4 1/2"	1/4 Lower	50
IPCG36045-4LNL	Steel	30 Hg"/60#	Vacuum/Pressure	4 1/2"	1/4 Lower	50
IPCG31045-4LNL	Steel	30 Hg"/160#	Vacuum/Pressure	4 1/2"	1/4 Lower	50





# Pressure Gauges - Liquid Filled



EILPG Series



ILPG Series

## Liquid Filled Pressure Gauge Features:

- Stainless steel or black steel case
- Glycerine Filled, Phosphor bronze bourdon tube
- Accuracy +/- 3-2-3%
- 2" or 2 1/2" Dial face with clear acrylic lens
- Crimped stainless steel ring
- For use in high vibration, corrosion situations
- **TO BE USED WITH AIR OR WATER ONLY.**



Part Number	Case	Range	Type	Dial Size	MIP Conn.	Ctn Qty
<b>2" DIAL SIZE, LIQUID FILLED</b>						
EILPG302-4L	Steel	0-30#	Pressure	2"	1/4" Lower	100
EILPG602-4L	Steel	0-60#	Pressure	2"	1/4" Lower	100
EILPG602-4B	Steel	0-60#	Pressure	2"	1/4" Back	100
EILPG1002-4L	Steel	0-100#	Pressure	2"	1/4" Lower	100
EILPG1002-4B	Steel	0-100#	Pressure	2"	1/4" Back	100
EILPG1602-4L	Steel	0-160#	Pressure	2"	1/4" Lower	100
EILVG302-4L	Steel	0-30 Hg"	Vacuum	2"	1/4" Lower	100
EILPG302-4LSS	Stainless Steel	0-30#	Pressure	2"	1/4" Lower	100
EILPG602-4LSS	Stainless Steel	0-60#	Pressure	2"	1/4" Lower	100
EILPG602-4BSS	Stainless Steel	0-60#	Pressure	2"	1/4" Back	100
EILPG1002-4LSS	Stainless Steel	0-100#	Pressure	2"	1/4" Lower	100
EILVG302-4LSS	Stainless Steel	0-30 Hg"	Vacuum	2"	1/4" Lower	100
<b>2 1/2" DIAL SIZE, LIQUID FILLED</b>						
ILPG3025-4L	Stainless Steel	0-30#	Pressure	2 1/2"	1/4 Lower	50
ILPG6025-4L	Stainless Steel	0-60#	Pressure	2 1/2"	1/4 Lower	50
ILPG10025-4L	Stainless Steel	0-100#	Pressure	2 1/2"	1/4 Lower	50
ILPG16025-4L	Stainless Steel	0-160#	Pressure	2 1/2"	1/4 Lower	50
ILPG20025-4L	Stainless Steel	0-200#	Pressure	2 1/2"	1/4 Lower	50
ILPG30025-4L	Stainless Steel	0-300#	Pressure	2 1/2"	1/4 Lower	50
ILPG40025-4L	Stainless Steel	0-400#	Pressure	2 1/2"	1/4 Lower	50
ILVG3025-4L	Stainless Steel	0-30 Hg"	Vacuum	2 1/2"	1/4 Lower	50
ILCG36025-4L	Stainless Steel	30 Hg"/60#	Vacuum/Press	2 1/2"	1/4 Lower	50



# Pressure Gauges - NO LEAD Liquid



EILPG Series



ILPG Series

## Liquid Filled Pressure Gauge Features:

- Stainless steel or black steel case.
- Glycerine filled, phosphor bronze bourdon tube.
- Accuracy +/- 3-2-3%.
- 2" or 2 1/2" Dial face with clear acrylic lens.
- Crimped stainless steel ring.
- For use in high vibration, corrosion situations.
- **Third party certified to NSF/ANSI 372.**
- No lead brass or stainless steel sockets.
- **TO BE USED WITH AIR OR WATER ONLY.**

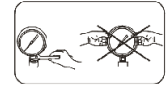

CAUTION

Part Number	Case	Range	Type	Dial Size	MIP Conn.	Ctn Qty
<b>2" DIAL SIZE, LIQUID FILLED</b>						
EILPG302-4LNL	Steel	0-30#	Pressure	2"	1/4" Lower	100
EILPG602-4LNL	Steel	0-60#	Pressure	2"	1/4" Lower	100
EILPG602-4BNL	Steel	0-60#	Pressure	2"	1/4" Back	100
EILPG1002-4LNL	Steel	0-100#	Pressure	2"	1/4" Lower	100
EILPG1002-4BNL	Steel	0-100#	Pressure	2"	1/4" Back	100
EILPG1002-8BNL	Steel	0-100#	Pressure	2"	1/8" Back	100
EILPG1602-4LNL	Steel	0-160#	Pressure	2"	1/4" Lower	100
EILPG2002-4LNL	Steel	0-200#	Pressure	2"	1/4" Lower	100
EILVG302-4LNL	Steel	0-30 Hg"	Vacuum	2"	1/4" Lower	100
EILVG302-4BNL	Steel	0-30 Hg"	Vacuum	2"	1/4" Back	100
<b>2 1/2" DIAL SIZE, LIQUID FILLED</b>						
EILPG3025-4LNL	Stainless Steel	0-30#	Pressure	2 1/2"	1/4 Lower	50
ILPG6025-4LNL	Stainless Steel	0-60#	Pressure	2 1/2"	1/4 Lower	50
ILPG10025-4LNL	Stainless Steel	0-100#	Pressure	2 1/2"	1/4 Lower	50
ILPG16025-4LNL	Stainless Steel	0-160#	Pressure	2 1/2"	1/4 Lower	50
ILPG20025-4LNL	Stainless Steel	0-200#	Pressure	2 1/2"	1/4 Lower	50
ILPG30025-4LNL	Stainless Steel	0-300#	Pressure	2 1/2"	1/4 Lower	50
ILPG40025-4LNL	Stainless Steel	0-400#	Pressure	2 1/2"	1/4 Lower	50
ILVG3025-4LNL	Stainless Steel	0-30 Hg"	Vacuum	2 1/2"	1/4 Lower	50
ILVG3025-4BNL	Stainless Steel	0-30 Hg"	Vacuum	2 1/2"	1/4 Back	50
ILCG36025-4LNL	Stainless Steel	30 Hg"/60#	Vacuum/Press	2 1/2"	1/4 Lower	50

\* 316 Stainless steel internals and mount.



**www.cbsupplies.ca**  
 Phone: (866) 503-5523 Fax: (888) 562-2095  
 AGI@cbsupplies.ca



17.008A



# Test Kits & Specialty Gauges



### Pool Test Kit Features:

- For pressure testing pool systems
- Unassembled kits individually boxed
- Includes PVC Sch 40 Reducing Tee, PVC Sch 40 Reducing Bushing, Brass Boiler Drain, 3/4", 60# 2" plastic case pressure gauge, 1/4" lower brass mount.

Part Number	Description	Ctn Qty
TK150	1 1/2" Pool Test Kit	8
TK200	2" Pool Test Kit	8



### Pressure Air Test Gauge Features:

- Quick, easy means of pressurizing and monitoring plumbing systems for leakage.
- Attach to hose bibb.
- Includes brass hex manifold, air valve, 2" 200# gauge, garden hose thread fitting.

Part Number	Description	Ctn Qty
PATG200	Pressure Air Test Gauge	30



PGBS

### Pressure Gauge Brass Snubber Features:

- Use with any pressure gauge subjected to rapidly fluctuating pressures or sudden shock pressure.
- Brass housing with high strength sintered, porous type snubbing element.

Part Number	Size/Description	Ctn Qty
PGBS1/4	1/4" mpt x 1/4" fpt Brass Snubber	50/500



PTG1002

### Pressure Test Gauge Features:

- 0-100 psi, 2" plastic lens.
- Brass test fitting with pressure release button.
- Heavy rubber boot to protect gauge from damage.

Part Number	Size	Pressure Setting/Description	Ctn Qty
PTG1002	2" case	0-100# Pressure test gauge	50



WTG

### Water Test Gauge Features:

- Quick, easy method to test a wide range of pressure systems for leakage.
- 2 1/2" dial face, steel case pressure gauge w/ plastic lens.
- With standard 3/4" FGHT swivel garden hose connection with rubber washer.
- Attach to hose bibbs, boiler drains and lawn faucets for pressure testing.
- "MP" series MAX pointer arm measures maximum water surge or pressure drop.
- Individually cartoned.



WTG MP

Part Number	Size	Pressure Setting/Description	PSI dial increments	Ctn Qty
WTG100	2 1/2"	0-100# water test gauge, fght	1	50
WTG200	2 1/2"	0-200# water test gauge, fght	2	50
WTG300	2 1/2"	0-300# water test gauge, fght	3	100
WTG100MP	2 1/2"	0-100# gauge with MAX pointer	1	50
WTG200MP	2 1/2"	0-200# gauge with MAX pointer	2	50
WTG300MP	2 1/2"	0-300# gauge with MAX pointer	3	50



# Gas Test Gauges, Flowmeters



GTG

### Gas Test Gauge Features:

- Quick, easy means of pressurizing & monitoring gas systems for leakage.
- Completely assembled - brass hex manifold, air valve with plastic cap and 2" dial face, steel case pressure gauge with plastic lens.
- Manifold also available separately: 3/4" fpt connection with 1/4" fpt gauge tap and 1/8" fpt air valve tap.
- Individually cartoned and available in 15, 30, 60 and 100 psi.



GTMAV



GTM3/4

Part Number	Description	Gauge Increments	Ctn Qty
GTG15	Gas test gauge, 3/4" fpt, 0-15#	1/10 lb.	50
GTG30	Gas test gauge, 3/4" fpt, 0-30#	1/2 lb.	50
GTG60	Gas test gauge, 3/4" fpt, 0-60#	1/10 lb.	50
GTG100	Gas test gauge, 3/4" fpt, 0-100#	1 lb.	50
GTM3/4	Brass Gas test manifold only		100

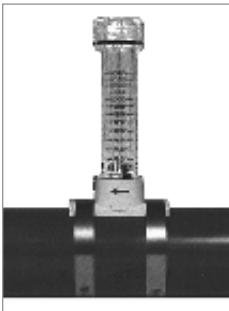

U88 Series

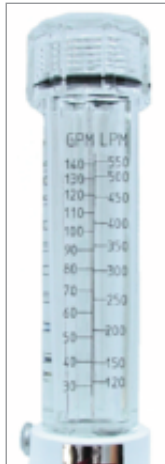

### Flow Meter Features:



- Economical, easy to install, easy to maintain.
- Calibrated in GPM/LPM with easy-to-read numbering.
- Available 1" - 4" pipe size.
- Durable acrylic construction.
- Supplied with 2 clamps and rubber gasket seal.
- Maximum temperature limit = 120 °F, Maximum pressure limit = 120 psi.

ISO 9002

Part Number	Nominal Pipe Size	Range GPM/LPM
U8800424	1"	5-35 / 20-130
U8800438	1 1/4"	10-60 / 40-220
U8800439	1 1/2"	20-80 / 80-300
U8800440	2"	30-140 / 120-550
U8800441	2 1/2"	40-200 / 160-750
U8800442	3"	80-350 / 300-1300
U8800443	4"	150-600 / 600-2200



# Ball Valves PVC Single Union for Pool & Spa



PV1450 Series



PV1452, PV1453 Series

ISO 9002



### MATERIAL SPECIFICATIONS

Body	PVC
End Adapter	PVC
Union Nut	PVC
Ball	PVC
Stem	PVC
Handle	ABS
Union o-rings	EPDM
Seat Seals	PTFE
Stem o-rings	EPDM

### PVC Single Union Ball Valve Features:

- PVC Type 1 construction for compatibility in joining rigid PVC and flex vinyl pipes.
- PTFE seats.
- Double EPDM o-ring seal on stem: single EPDM o-ring seal on union end.
- Fully round ball prevents foreign matter from scoring seats.
- Tee handle for quarter turn on/off with stops.
- Working pressure: 150 PSI at 72°F, 100 PSI at 120°F.
- Threaded or socket.
- Manufactured for AGI in an ISO 9002 facility.
- Imported

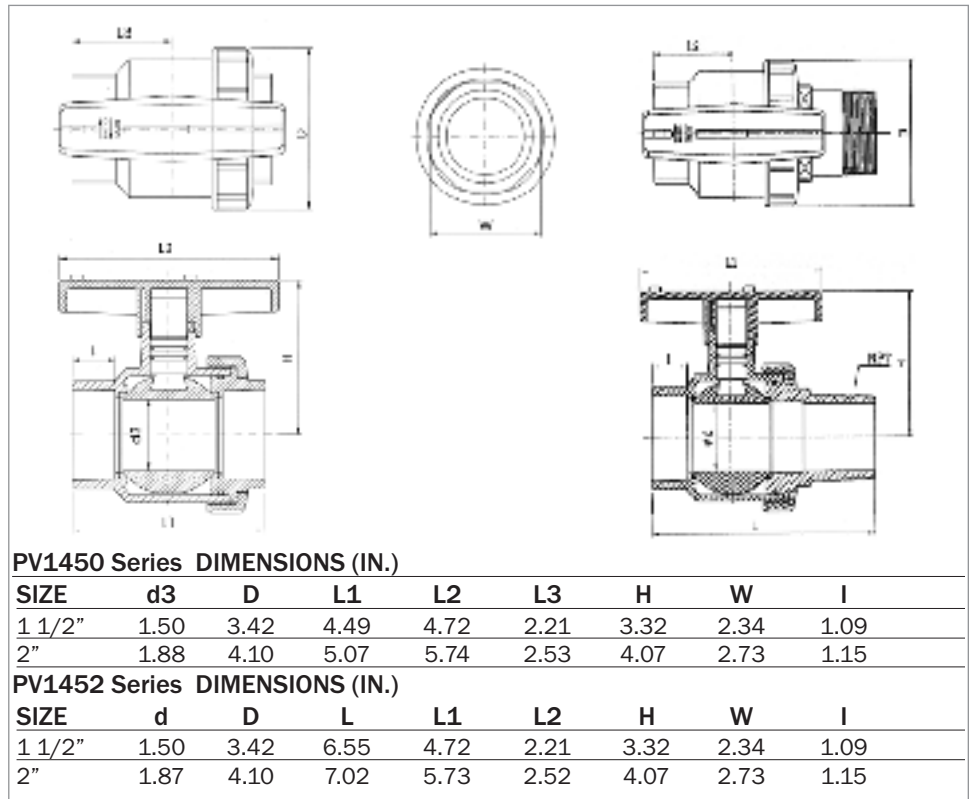

Part Number	Threaded/Slip	Size	Ctn Qty
PV1450-11/2	Slip	1-1/2"	48
PV1450-2	Slip	2"	24
PV1451-11/2	Threaded	1-1/2"	48
PV1451-2	Threaded	2"	24
PV1452-11/2	Slip x Extended MIP	1 1/2"	24
PV1452-2	Slip x Extended MIP	2"	24
PV1453-11/2	FPT x Extended MIP	1 1/2"	24
PV1453-2	FPT x Extended MIP	2"	12







# Valves PVC Single Union, 3-way CPVC



1350 Series



## PVC Single Union Ball Valve Features:

- PVC Type 1 construction for compatibility in joining rigid PVC and flex vinyl pipes.
- **Buna "N" O-Ring seal; HDPE seats.**
- 1-1/4 deep sockets on both ends for extra cementing surface area.
- Acme thread on assembly nut prevents cross threading.
- Tee handle for quarter turn on/off with stops.
- Working pressure: 150 PSI at 72°F, 100 PSI at 120°F.
- Threaded or socket.
- Made in USA.



Part Number	Threaded/Socket	Size	Ctn Qty
1350-15	Socket	1-1/2"	12
1350-20	Socket	2"	6
1351-15	Threaded	1-1/2"	12

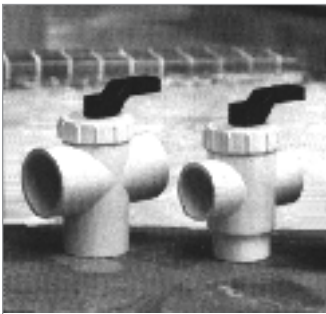

1930 Series

## CPVC Three-Way Valve Features:

- For pool & spa applications.
- Made of CPVC plastic
- Diverts water anywhere diversion is required.
- Positive seal diverter prevents reverse flow.
- Diverter seals are made of a special lubricated EPDM material
- Available 1 1/2" - 2" slip with 2" and 2 1/2" spigot.
- Rated at 160° F, 125 PSI



Part Number	Description	Ctn Qty
1930-15	1 1/2" slip x 2" spigot	12
1930-20	2" slip x 2 1/2" spigot	12





# Ball Valves Economy PVC Molded-in-Place



## Economy Series PVC Molded-In-Place Ball Valve Features:

- Heavy duty thermoplastic white PVC (Type 1, Grade 1) construction.
- White body, blue handle.
- Tee handle on 1/2" through 2". Lever handle on 2 1/2", 3" and 4".
- EPDM seats provide excellent chemical resistance.
- EPDM "o" ring stem seal.
- 150 PSI working pressure at 73°F water, non-shock.
- Maintenance free compact design.
- Severe shock loads and misalignment stress are absorbed by the valve body, not the ball & seat, minimizing the chance of uneven wear & leakage.
- Individually cartoned.
- Imported.

EMIP TE/SE Series IPS DIMENSIONS (IN.)						
SIZE	d	d1	D	L1	L	H
1/2"	0.591	.0839	1.24	0.80	2.9	1.78
3/4"	0.792	1.051	1.45	0.89	3.4	2.01
1"	0.981	1.315	1.77	1.08	4.0	2.26
1 1/4"	1.262	1.661	2.07	1.06	4.3	2.66
1 1/2"	1.421	1.902	2.49	1.14	4.8	2.91
2"	1.832	2.374	3.01	1.42	5.7	3.32
2 1/2"	2.492	2.874	3.54	1.80	7.2	4.07
3"	3.153	3.5	4.25	2.4	9.3	4.47
4"	3.821	4.5	5.21	2.52	10.1	4.89

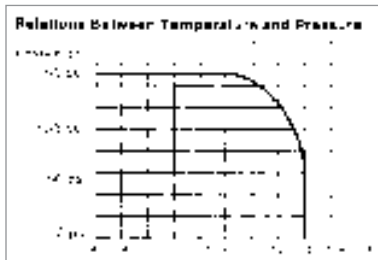
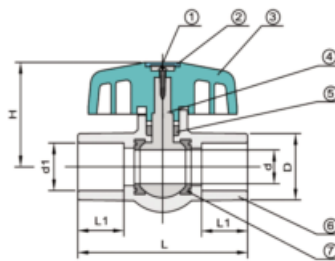

### MATERIAL SPECIFICATIONS

1	Screw	Zinc Plated Steel
2	Cap	ABS
3	Handle	ABS
4	Ball	PVC
5	Stem Seal o-ring	EPDM
6	Body	PVC
7	Seat Seal	EPDM

SIZE	CV
CV (GPM)/(1 lbf/in <sup>2</sup> ) <sup>1/2</sup> Opening Rate: 90°	
1/2"	14.5
3/4"	29.5
1"	48.0
1 1/4"	71.0
1 1/2"	135.0
2"	180.0
2 1/2"	225.0
3"	400.0
4"	865.9

Threaded Part Number	Slip Part Number	Size	Master Case Qty
EMIP50TE	EMIP50SE	1/2"	210
EMIP75TE	EMIP75SE	3/4"	137
EMIP100TE	EMIP100SE	1"	95
EMIP125TE	EMIP125SE	1 1/4"	56
EMIP150TE	EMIP150SE	1 1/2"	36
EMIP200TE	EMIP200SE	2"	24
EIMP250TE	EMIP250SE	2 1/2"	9
EMIP300TE	EMIP300SE	3"	8
EMIP400TE	EMIP400SE	4"	6



# Ball Valves

## PVC Sch 80 Molded-in-Place



ISO 9002

### MATERIAL SPECIFICATIONS

Body	PVC
Seat Seal	EPDM, PTFE
Ball	PVC
Stem Seal o-ring	EPDM
Handle	ABS
Bolt	Zinc Plated Steel
Cap	ABS

### SCH 80 Series PVC Molded-In-Place Ball Valve Features:

- Heavy duty thermoplastic white PVC (Type 1, Grade 1) construction. Materials meet NSF standards.
- Meets ASTM 2467 Schedule 80.
- White body, red handle.
- Available with PTFE or EPDM seats providing excellent chemical resistance.
- EPDM “o” ring stem seal
- **150 PSI** working pressure at 73°F water, non-shock.
- Maintenance free compact design.
- Severe shock loads and misalignment stress are absorbed by the valve body, not the ball & seat, minimizing the chance of uneven wear & leakage.
- Individually cartoned.
- Manufactured for AGI in an ISO 9002 facility.
- **Third party certified to NSF/ANSI 372.**



Certified to  
ANSI-NSF 61 &  
ANSI-NSF 61 Annex G



**NO LEAD**  
< 0.25% Pb by  
weighted avg  
Third Party Certified  
to NSF / ANSI 372

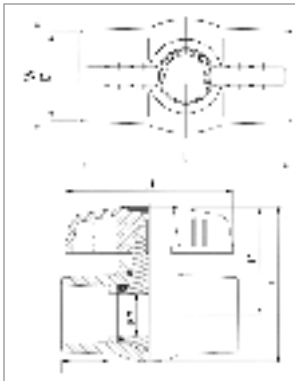

### HMIP TE/SE and T/S Series IPS DIMENSIONS (IN.)

SIZE	d	D	L	L1	I	H1	H2	W
1/2"	.55	1.17	3.24	2.73	.87	2.42	1.68	1.48
3/4"	.78	1.48	3.71	3.43	1.00	3.04	2.11	1.67
1"	.98	1.76	4.13	3.90	1.12	3.63	2.54	2.22
1 1/4"	1.17	2.11	4.45	3.90	1.25	3.82	2.61	2.46
1 1/2"	1.40	2.42	5.07	4.25	1.37	4.49	3.04	2.93
2"	1.82	3.00	5.74	5.23	1.50	5.27	3.47	3.59
2 1/2"	2.34	3.59	7.96	6.94	1.75	6.24	4.10	4.29
3"	3.00	4.13	8.93	8.74	1.88	7.41	4.84	5.19
4"	3.94	5.27	11.70	10.76	2.25	9.09	5.77	6.63

### Relation Between Temperature and Pressure

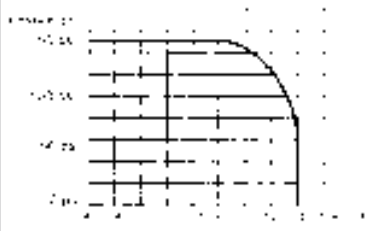

CV (GPM/(1 lbf/in<sup>2</sup>)<sup>1/2</sup>)  
Opening Rate: 90°

SIZE	CV
1/2"	8.84
1"	25.24
1 1/4"	38.53
1 1/2"	51.28
2"	96.67
2 1/2"	162.37
3"	438.81
4"	865.90

CMIP-C Series excluded

### WITH EPDM SEATS

Threaded	Slip	Size	Ctn Qty
Part Number	Part Number		
HMIP50TE	HMIP50SE	1/2"	100
HMIP75TE	HMIP75SE	3/4"	100
HMIP100TE	HMIP100SE	1"	100
HMIP125TE	HMIP125SE	1 1/4"	100
HMIP150TE	HMIP150SE	1 1/2"	48
HMIP200TE	HMIP200SE	2"	24
HIMP250TE	HMIP250SE	2 1/2"	12
HMIP300TE	HMIP300SE	3"	12
HMIP400TE	HMIP400SE	4"	6

### WITH PTFE SEATS

Threaded	Slip	Size	Ctn Qty
Part Number	Part Number		
HMIP50T	HMIP50S	1/2"	100
HMIP75T	HMIP75S	3/4"	100
HMIP100T	HMIP100S	1"	100
HMIP125T	HMIP125S	1 1/4"	100
HMIP150T	HMIP150S	1 1/2"	48
HMIP200T	HMIP200S	2"	24



www.cbsupplies.ca  
Phone: (866) 503-5523 Fax: (888) 562-2095  
AGI@cbsupplies.ca





# Ball Valves

## CPVC Sch 80 Molded-in-Place



ISO 9002

### MATERIAL SPECIFICATIONS

Body	CPVC
Seat Seal	PTFE
Ball	CPVC
Stem Seal	EPDM
Handle	ABS
Bolt	Zinc Plated Steel
Cap	ABS

**FLOWGUARD GOLD**  
PIPE & FITTINGS



Certified to  
ANSI-NSF 61 &  
ANSI-NSF 61 Annex G



**NO LEAD**  
< 0.25% Pb by  
weighted avg  
Third Party Certified  
to NSF / ANSI 372

### SCH 80 Series CPVC Molded-in-Place Ball Valve Features:

- Made with Flo Guard Gold CPVC material.
- Heavy duty thermoplastic CPVC construction for hot water use.
- NSF listed.
- Meets ASTM 2467 Schedule 80.
- CTS slip x slip - cream body, orange handle.
- PTFE seats providing excellent chemical resistance.
- EPDM O-Ring stem seal.
- Working pressure 75 PSI at 180°F.
- Maintenance free compact design.
- Severe shock loads & misalignment stress are absorbed by the valve body, not the ball & seat, minimizing the chance of uneven wear & leakage.
- Individually cartoned.
- Manufactured for AGI in an ISO 9002 facility.
- **Third party certified to NSF/ANSI 372.**



### CMIP "C" Series CTS DIMENSIONS (IN.)

SIZE	d	D	L	L1	I	H1	H2	W
1/2"	.47	.94	2.65	2.34	.50	1.91	1.33	1.21
3/4"	.55	1.17	3.24	2.73	.87	2.42	1.68	1.48
1"	.78	1.48	3.71	3.43	.90	3.04	2.11	1.91

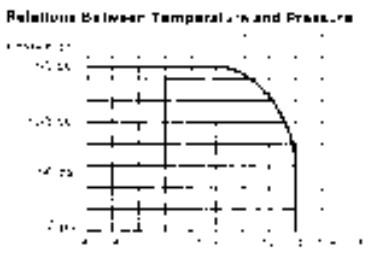

CV (GPM/(1 lbf/in<sup>2</sup>)<sup>1/2</sup>)

Opening Rate: 90"

SIZE	CV
1/2"	14.5
3/4"	29.5
1"	48.0

Part Number	Description	Ctn Qty
<b>CPVC Ball Valve, Copper Tube Size, SLIP X SLIP</b>		
CMIP50C	1/2" SLIP X SLIP	100
CMIP75C	3/4" slip x slip	100
CMIP100C	1" slip x slip	100



[www.cbsupplies.ca](http://www.cbsupplies.ca)  
Phone: (866) 503-5523 Fax: (888) 562-2095  
AGI@cbsupplies.ca



17.013



# Slice Gate Valves - PVC

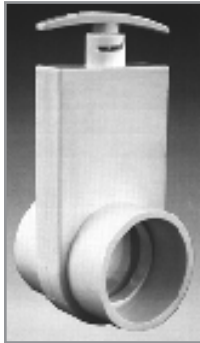

VSGV Uni-Body



VSGV 3 piece body



VSGV 3 piece body with union

## PVC Slice Gate Valve Features:

- Designed for pool & spa, irrigation, plumbing, waste water and agricultural applications.
- Stainless steel shaft prevent rust and corrosion.
- Ozone & chemical resistant Santoprene™ materials.
- Santoprene™ seals are integrated to the paddle to eliminate any chance of torn or punctured gaskets.
- Maximum working pressure 50 psi (through 2”).
- Solvent cement traps to catch excess glue.
- Every valve tested at double recommended working pressure.
- Valterra's patent pending triple o-ring neck seal to ensure against any chance of shaft leakage.

## Unibody Design

- One piece uni-body design.
- Combination socket ID x spigot OD for installation flexibility.
- Locking handle provides positive shutt-off and easy gate opening.

## 3 Piece body

- Three piece configuration allows for repair or can be used as a union.
- Three piece configuration easily disassembles for inline service.

Part Number	Description	Max PSI	Ctn Qty
<b>Uni-Body</b>			
VSGV2101	1 1/2" slip x slip	45	30
VSGV2201	2" slip x slip	40	20
<b>* Unibody 2" slip hubs are 2" slip or 2 1/2" spig</b>			
<b>Three Piece Body</b>			
VSGV150SL	1 1/2" slip x slip	45	30
VSGV150FIPTXMIPT	1 1/2" fipt x mipt	45	40
VSGV150FIPTxMIPTABS	1 1/2" fipt x mipt ABS	45	26
VSGV150SLU	1 1/2" slip x union slip	45	38
VSGV150MTU	1 1/2" mipt x union slip	45	38
VSGV150SP	1 1/2" slip x spigot	45	30
VSGV150SD	1 1/2" step down pool hose x mipt ABS		40
VSGV200SL	2" slip x slip	40	20
VSGV200SP	2" slip x spigot	40	34
VSGV300SL	3" slip x slip	30	15
VSGV400SL	4" slip x slip w/ metal handle	20	6
VSGV600SL	6" slip x slip w/ stainless handle	10	1
VSGV800SL	8" slip x slip w/ stainless handle	10	1
VSGV1000SL	10" slip x slip w/ stainless handle	10	1
VSGV1200SL	12" slip x slip w/ stainless handle	10	1



SGV - SL Series

### PVC Slice Gate Valve

- One piece “Uni-Body” PVC Construction. Guaranteed NO HUB LEAKS or loose bolts.
- 1/4 turn “Cam-Lock” for 100% shut-off..
- Internal “snap-lock” feature ensures valve will remain totally open, providing 100% flow with no restriction.
- Stainless steel shaft prevents rust and corrosion.
- Glass filled poly-pro tapered gate design for 100% sealing.
- Integrally molded seal on gate. - No pinched or torn gaskets.
- Seals are “Santoprene” that have been impregnated

with a permanent

lubricant. Never needs lube yet will provide continuous smooth operation. Ozone and chemical resistant for much longer life.



- Santoprene buttons on gate provides smooth operation without sticking.
- Every valve water tested at 100PSI and random quick burst tested at 400 PSI. Virtually no chance of leaky valves in the field at standard operating pressures.
- Maximum recommended operating pressure is 50 PSI.
- Glue wells on all slip-socket configuration catches excess glue during plumbing.



SGV-Sp and SGV-SLU Series

Part Number	Size	Description	Ctn/Case Qty
SGV150SL	1 1/2"	Slip x Slip	14/56
SGV200SL	2"	Slip x Slip	12/48
SGV250SL	2 1/2"	Slip x Slip	5/20
SGV150SP	1 1/2"	Slip x Spigot	14/56
SGV200SP	2"	Slip x Spigot	12/48
SGV150SLU	1 1/2"	Slip x Slip with Union	10/40
SGV200SLU	2"	Slip x Slip with Union	10/40





# Check Valves - PVC Swing

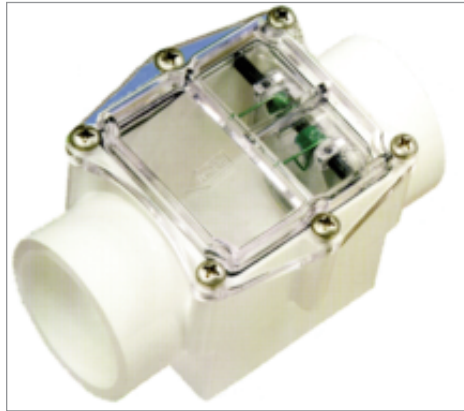

MCRV Series

## “CR” Full Flow Corrosion Resistant Check Valve Features:

- Protects heat exchangers from potential damage by inline chlorinators.
- Maintains full flow circulation system.
- Proprietary designed hastelloy spring.
- Glass filled Noryl injection molded shaft.
- 100% silicone gasket never requires lubrication.
- Clear sight glass. Removable, servicable.
- 3 IPS sizes in one valve. 1 1/2” slip with bushing, 2” slip and 2 1/2” spigot. ( 1 1/2” bushing sold separately.)
- Spring loaded flapper/gate mechanism assures full flow and minimum cavitation.
- Positive water seal when in the closed position.
- “CR” valve can be installed in virtually any position.
- Use in highly corrosive conditions and conditions needing backflow prevention.

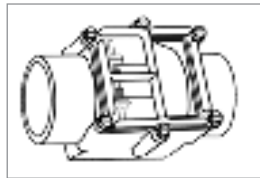

MCRV Series

Part Number	Description	Size	Ctn Qty
MCRV801-20H	PVC CR Swing Check Valve	2” Slip x Slip	12
60104028	CR Swing Check Bushing	2” Sp x 1 1/2” Slip	1

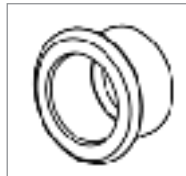

Bushing

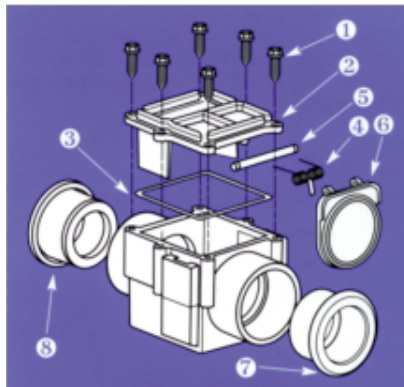

CR VALVE REPLACEMENT PARTS			
ID	Part Number	Description	Ctn Qty
1	M04030066	#14 x 1” Phillips Pan Head SS Screw	6
2	M0191401020	Lid	1
3	0301-154	O-Ring	1
4	M0405001	Spring	1
4	0405-001-H	Hastelloy Spring	1
5	M0401005P	Shaft	1
6	M0081201020	Gate Assembly	1
7	M0060504028	Adapter 2” sp x 1 1/2” Slip, Black	1
8	M0060104028	Adapter, 2” sp x 1 1/2” Slip, White	1





# Check Valves - PVC Swing



MCV Series

### “Smart” Swing Check Valve Features:

- Patented innovation in swing check valve technology eliminates in-line flow restriction of conventional check valves.
- Spring loaded swing check flapper/gate allows full flow and reliable back flow prevention.
- Standard “smart” check valve remains closed to 1/2 psi, then open for full flow.
- Magnetic “smart” check valves remain closed to 2 psi, then open for full flow.

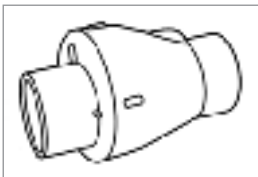

MCV821 Series

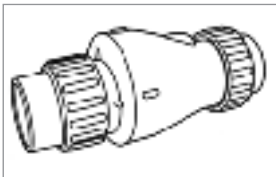

MCV823 Series



MCV850 Series

Part Number	Size	Description	Spring Tension	Ctn Qty
MCV821-10	1"	Slip x Slip	1/2 lb.	12
MCV821-10C	1"	Slip x Slip CLEAR	1/2 lb.	12
MCV821-15	1 1/2"	Slip x Slip	1/2 lb.	12
MCV821-15C	1 1/2"	Slip x Slip CLEAR	1/2 lb.	12
MCV821-20	2"	Slip x Slip	1/2 lb.	12
MCV821-20C	2"	Slip x Slip CLEAR	1/2 lb.	12
MCV821-20M	2"	Slip x Slip w/magnet	2 lb.	12
MCV821-20MC	2"	Slip x Slip w/magnet CLEAR	2 lb.	12
MCV823-10	1"	Union x Union	1/2 lb.	12
MCV823-10C	1"	Union x Union CLEAR	1/2 lb.	12
MCV823-15	1 1/2"	Union x Union	1/2 lb.	12
MCV823-15C	1 1/2"	Union x Union CLEAR	1/2 lb.	12
MCV823-20	2"	Union x Union	1/2 lb.	12
MCV823-20C	2"	Union x Union CLEAR	1/2 lb.	12
MCV823-20M	2"	Union x Union w/magnet	2 lb.	12
MCV823-20MC	2"	Union x Union w/magnet CLEAR	2 lb.	12
MCV850-15	1 1/2"	Check/Slice Combo Union x Slip		12
MCV850-20	2"	Check/Slice Combo Union x Slip		12





# Check Valves - PVC Spa, By-Pass



1050 Series



## PVC Spa Air Valve Features:

- Drip proof seal at low pressure.
- 1 1/2" IPS deep socket connection with 2" IPS OD spigot
- Excess solvent cement trap at base of socket to help prevent solvents from entering sealing area.
- Minimum restriction of air flow, using 1/4 lb. spring resulting in less burden on blower motor.
- Domed shaped seat for even air flow.
- EPDM seal.
- Stainless steel spring.
- NSF approved.

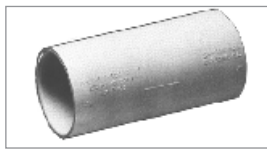
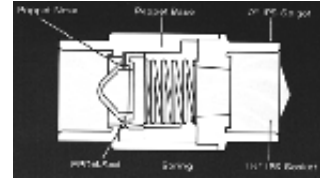

1095 Series

## PVC In-Line By-Pass Check Valve Features:

- In-line shape takes less space.
- Raised valve seat prevents excess cement or solvent from affecting the seal area.
- Poppet is equipped with EPDM seal.
- Body is made of Type 1 PVC.
- All metal parts are stainless steel.
- Valve stem is reinforced w/ full length stainless steel shaft.
- Static pressure tested: 150 psi @ 72° F. Back pressure tested at 150 psi.
- Quick burst test proves in excess of 500 psi
- 2" iron pipe size
- Valve can be used on 1-1 1/2" pipe by use of a PVC Sch 40 bushing.
- Begins to open at 1/2 lb. or 5 lb.
- NSF approved.

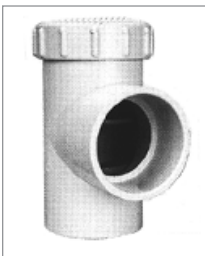
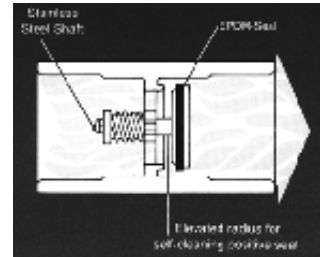

1901/1903 Series

## CPVC 90° Spring Check Valve Features:

- Use in pool, spa applications.
- CPVC body with corrosion proof poppet.
- Spring made of 302 stainless.
- Available with 1 lb. or 3 lb. spring tension.
- NSF approved.

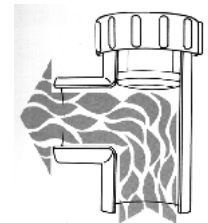

See "FLO/NDS" tab for a complete line of Flo Control PVC check valves.

Part Number	IPS Size	Body Length	Ctn Qty
<b>PVC Spa Air Valve - 1-1/2" ips socket / 2" ips o.d. spigot</b>			
1050-20	2"	5-1/8"	12
<b>PVC In Line By-Pass Check Valve</b>			
1095-20	2" w/ 5# spring	5"	12
<b>CPVC 90° Spring Check Valve, w/ stainless steel poppet</b>			
1901-15	1 1/2" check valve, 1 lb. tension		12
1903-15	1 1/2" check valve, 3 lb. tension		12
1901-20	2" socket x 2 1/2" spigot valve, 1 lb. tension		12
1903-20	1" socket x 2 1/2" spigot valve, 3 lb. tension		12



# Float Valves - Bronze, No Lead

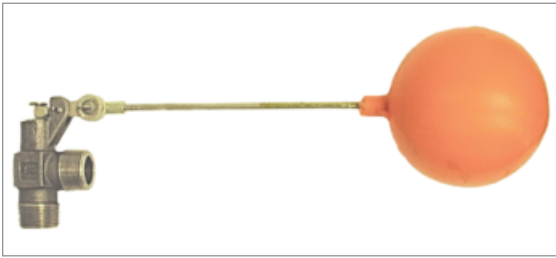

## Bronze, NO LEAD Bronze Float Valve Features:

- Cast bronze or NO LEAD bronze body
- Buna-N Disc
- Heavy Duty
- Tapped for 1/4"-20SAE rod
- Threaded outlet
- Rated at 125 psi
- Third party certified to NSF/ANSI 372.



BFV Series

Part Number	Size	Inlet	Outlet	Tapped	Ctn Qty
BFVNL1/2	1/2"	1/2" mpt	1/2" mpt	1/4"-20SAE	10/100
BFVNL3/4	3/4"	3/4" mpt	3/4" mpt	1/4"-20SAE	10/80
BFVNL1	1"	1" mpt	1" mpt	1/4"-20SAE	10/40



BFVR Series

## Stainless Steel Rods Features:

- Stainless Steel SAE
- Male thread both ends
- Third party certified to NSF/ANSI 372.



Part Number	Length	Thread	Fits Valve Size	Ctn Qty
BFVR8	8"	1/4"-20SAE	1/2" - 1"	50/400
BFVR10	10"	1/4"-20SAE	1/2" - 1"	50/300
BFVR12	12"	1/4"-20SAE	1/2" - 1"	50/300



BFVFP Series

## Plastic Float Features:

- PVC, Corrosion resistant.
- Lightweight
- Up to 175 ° F
- For open tank service only
- Bronze or NO LEAD bronze threaded connection.
- Third party certified to NSF/ANSI 372.



Part Number	Float Diam.	Buoyancy	Female Connection	Ctn Qty
BFVFPNL5	5"	2.17 lbs.	1/4"-20SAE	100
BFVFPNL6	6"	3.8 lbs.	1/4"-20SAE	100
BFVFPNL8	8"	9.87 lbs.	1/4"-20SAE	20





# Butterfly Valves - Ductile Iron



HBFV Series

## Ductile Iron Butterfly Valve Features:

- Designed for swimming pool, irrigation and water systems.
- Wafer body features 4 alignment holes.
- Lever lock handle (spring loaded) provides excellent manual control for balancing or shut off services.
- Notched throttling plate allows balancing in 10° increments in any position desired within 90° arc rotation of the disc.
- Positive bubble-tight shutoff with minimum torque.
- Seat face eliminates need for flange gaskets.
- Phenolic backed seats prevent collapse, are stretch resistant, blowout proof and field replacable.
- **EPDM seats** temperature rated at -30 °F to 275 °F.
- 420 stainless steel shaft
- Bidirectional dead-end capability for 250 psi (2" - 12").
- Compatible with ANSI 125/150 flanges.
- Designed to comply with MSS SP-67 and API 609.
- **Ductile iron, ENP plated disc.**
- Imported



HBFV GEAR Series



Part No.	Size	Weight(lbs)	Ctn Qty
<b>Ductile Iron ENP Plated Disc*</b>			
HBFV2	2"	7	1
HBFV2 1/2	2-1/2"	8	1
HBFV3	3"	10	1
HBFV4	4"	12	1
HBFV5	5"	15.5	1
HBFV6	6"	17.5	1
HBFV8	8"	33	1
HBFV10	10"	50	1
HBFV12	12"	74	1
<b>Ductile Iron ENP Plated Disc - GEAR DRIVE *</b>			
HBFV6-GEAR	6"	28.5	1
HBFV8 GEAR	8"	54	1
<b>Replacement Handles for HBFV Series</b>			
BFH2	2"		1
BFH3	3"		1
BFH4	4"		1
BFH5	5"		1
BFH6	6"		1
BFH8	8"		1
BFH10	10"		1
BFH12	12"		1

Flanges & Bolt kits available,  
see page P.28



# Butterfly Valves - Cast Iron

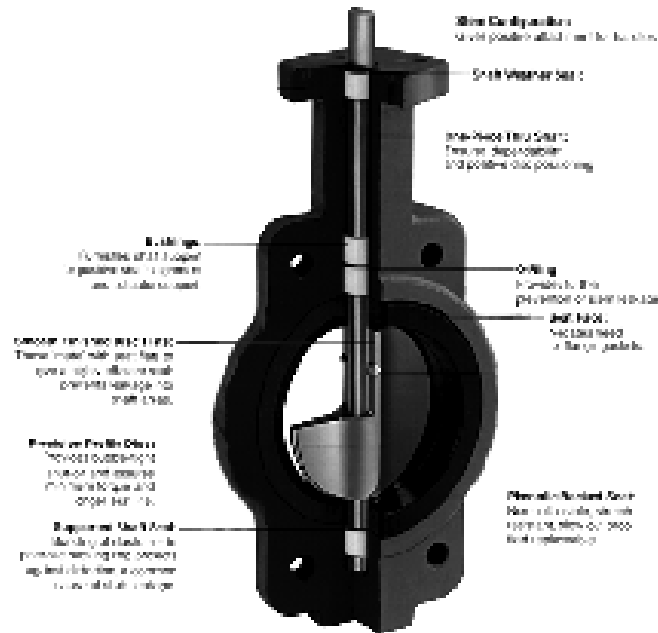

MATERIAL SPECIFICATIONS		
No.	Part	Material
1	Body	DUCTILE Iron
2	Disc	Ductile Iron
3	Seat	EPDM
4	Shaft	420 Stainless Steel
5	Key	Carbon Steel
6	O-ring	EPDM
7-9	Bushing	Nylon

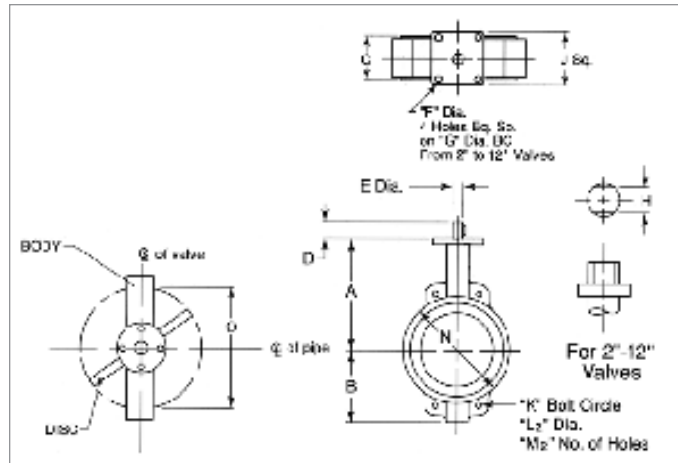
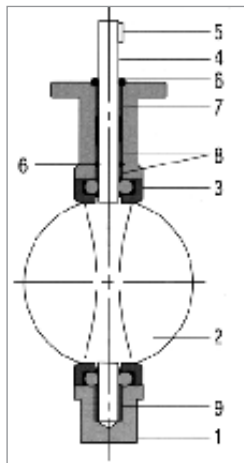

SIZE \ DIMENSION (in) for HBFV Series	A	B	C	D	E	F	G	H	J	K	L2	M2	N	O
2"	5.51	2.44	1.64	1.26	.50	.375	2.76	.39	2.75	4.75	.75	4	4.75	2.12
2 1/2"	6.02	2.76	1.75	1.26	.50	.375	2.76	.39	2.75	5.5	.75	4	5.50	2.57
3"	6.26	2.89	1.75	1.26	.50	.375	2.76	.39	2.75	6.0	.75	4	6.00	3.14
4"	7.01	4.49	2.00	1.26	.625	.375	2.76	.47	2.75	7.50	.75	4	7.50	4.13
5"	7.50	4.79	2.13	1.26	.75	.375	2.76	.55	2.75	8.50	.87	4	8.50	5.12
6"	8.01	5.55	2.12	1.26	.75	.375	2.76	.55	2.75	9.50	.87	4	9.50	6.13
8"	9.50	6.85	2.50	1.26	.875	.438	4.02	.67	3.75	11.75	.87	4	11.75	8.15
10"	10.75	8.19	2.50	1.58	1.125	.438	4.02	.87	3.75	14.25	1.00	4	14.29	9.98
12"	12.25	9.53	2.99	1.58	1.125	.438	4.02	.95	3.75	17.00	1.00	4	17.00	11.89



www.cbsupplies.ca  
 Phone: (866) 503-5523 Fax: (888) 562-2095  
 AGI@cbsupplies.ca



17.018A



# Butterfly Valves - PVC Sch 80



PBFV Series

ISO 9002



## PVC Sch 80 Butterfly Valves Features:

- 150 PSI working pressure.
- PVC body, polypropylene disc, and EPDM seat and o-ring.
- Flanged end design.
- Corrosion resistant.
- Excellent flow characteristics.
- Ideally suited for flow control in a minimum piping space.
- Clear indication of disc opening degree.
- Built in seat requires no additional gaskets between flanges.
- Manufactured for AGI in an ISO 9002 facility.
- Imported.

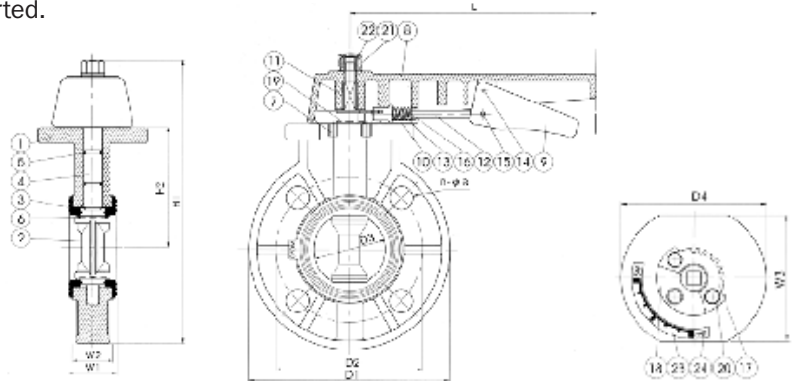

### MATERIAL SPECIFICATIONS

No.	Part	Material	Qty
1	Body	PVC	1
2	Disc	PP	1
3	Seat Seal	EPDM	1
4	Stem	SS 410	1
5	O-ring	EPDM	2
6	O-ring	EPDM	2
7	Inserted Nut	SS 41	3
8	Large Handle	ABS	1
9	Small Handle	ABS	1
10	Spring Lock	ABS	1
11	Handle Insert	SS	1
12	Handle Lever	SS 304	1
13	Spring	SS 304	1
14	Spring Pin	SS 304	1
15	Spring Pin	SS 304	1
16	Washer	SS 304	1
17	Locking Plate	SS 304	1
18	Gear Seat	PP + GF	1
19	Washer	SS 304	1
20	Bolt	SS 304	3
21	Nut	PVC	1
22	Insert Nut	C3604	1
23	Level	SS 304	1
24	Rivet	SS	2

CV (GPM/(1 lbf/in<sup>2</sup>)<sup>1/2</sup>)  
Opening Rate: 90°

SIZE	CV
2"	100.87
2 1/2"	137.82
3"	224.08
4"	409.51
5"	523.92
6"	1243.00

### DIMENSIONS \ SIZE (in)

	2"	2 1/2"	3"	4"	5"	6"	8"
D1	6.44	7.22	7.80	8.93	9.98	11.12	13.38
D2	4.70	5.44	5.94	7.43	8.42	9.42	11.64
D3	2.20	2.71	3.10	4.01	5.11	6.02	7.91
D4	4.13	4.66	4.84	5.26	6.40	6.64	7.84
L	7.92	7.92	7.92	9.91	11.86	11.86	11.86
H1	9.59	10.37	10.76	12.40	15.21	15.80	18.17
H2	4.02	4.41	4.49	5.27	5.85	6.90	8.19
W1	1.67	1.85	1.85	2.23	2.57	2.88	3.41
W2	1.35	1.45	1.45	1.83	2.22	2.53	3.06
W3	3.67	3.67	3.66	3.89	4.31	3.93	4.76
n-oe	.741	.741	.741	.741	.858	.858	.858

Part Number	Description	Ctn Qty
PBFV2	2" PVC Butterfly valve	4
PBFV21/2	2 1/2" PVC Butterfly valve	4
PBFV3	3" PVC Butterfly valve	4
PBFV4	4" PVC Butterfly valve	4
PBFV5	5" PVC Butterfly valve	4
PBFV6	6" PVC Butterfly valve	4
PBFV8	8" PVC Butterfly valve	1
<b>Replacement handles</b>		
PBFV2 HANDLE	2" PVC valve handle	1
PBFV21/2 HANDLE	2 1/2" PVC valve handle	1
PBFV3 HANDLE	3" PVC valve handle	1
PBFV4 HANDLE	4" PVC valve handle	1
PBFV5 HANDLE	5" PVC valve handle	1
PBFV6 HANDLE	6" PVC valve handle	1
PBFV8 HANDLE	8" PVC valve handle	1





PF Series

**ISO 9002**



### PVC Sch 80 Van Stone Flange Features:

- Two-piece van stone socket style.
- Class 150, Schedule 80
- Improve the security and safety of connections between pipes, valves & fittings.
- Imported - Manufactured for AGI in an ISO 9002 facility.

	DIMENSIONS \ SIZE (in)						
	2"	3"	4"	6"	8"	10"	12"
D1	5.93	7.49	8.93	11.08	13.38	15.83	18.76
D2	4.72	5.93	7.45	9.40	11.62	14.12	16.85
D3	2.96	4.21	5.19	7.45	9.28	12.09	14.20
d	1.99	3.00	3.98	6.08	7.96	9.98	11.97
d1	2.35	3.46	4.45	6.55	8.53	10.64	12.62
d2	2.37	3.48	4.48	6.59	8.57	10.68	12.67
H	1.68	2.11	2.50	3.32	4.60	5.85	7.45
T	.78	1.01	1.09	1.25	1.40	1.64	1.64
l	1.49	1.86	2.23	2.97	3.98	4.80	6.44
n-oe	.741	.741	.741	.858	.858	.936	.975

Part Number	Description	Ctn Qty
PF2	2" Flange	60
PF21/2	2 1/2" Flange	36
PF3	3" Flange	30
PF4	4" Flange	20
PF6	6" Flange	10
PF8	8" Flange	4
PF10	10" Flange	2
PF12	12" Flange	2

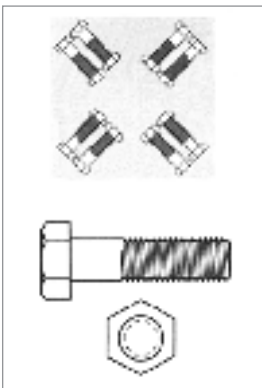

BBK Series

### Bolt Kit Features:

- For use with cast iron & PVC butterfly valves. BF8200, HBFV and PBFV Series
- ASTM-A307 grade black steel bolts and A563 finished nuts.
- Washers and Gaskets NOT included- Available upon request.

Part Number	Valve Size	Bolt Size	Bolts/Kit	Ctn Qty
BBK2	2"	5/8" x 5"	4	16
BBK2.5/3	2 1/2" and 3"	5/8" x 5 1/2"	4	16
BBK4	4"	5/8" x 6"	8	8
BBK5/6	5" and 6"	3/4" x 6 1/2"	8	8
BBK8	8"	3/4" x 7"	8	8
BBK10	10"	7/8" x 7 1/2"	12	3
BBK12	12"	7/8" x 8 1/2"	12	3



GSK Series

### Red Rubber Gasket Features:

- For use with butterfly valves, Sch 80 flanges
- Red rubber, 150 lbs., 1/8" full face.

Part Number	Valve Size
GSK11/2R	1 1/2"
GSK2R	2"
GSK21/2R	2 1/2"
GSK3R	3"
GSK4R	4"

Part Number	Valve Size
GSK5R	5"
GSK6R	6"
GSK8R	8"
GSK10R	10"
GSK12R	12"





# Butterfly Valve Installation Kits



PBCVIK Series



## Butterfly Valve Installation Kit Features:

- Everything needed for a quick, easy butterfly valve installation.
- Available with PVC Sch 80 or Ductile Iron butterfly valves.
- Custom kits available upon request.

## PVC Butterfly Valve Installation Kit Includes:

- One PBFV Series PVC Sch 80 Butterfly valve.
- Two PF Series PVC Sch 80 Van Stone flanges.
- Two red rubber GSK gaskets.
- Bolt kit with steel nuts and bolts.
- Steel washers.

Part Number	Size	Number of Nuts/Bolts	Number of Washers	Ctn Qty
PBCVIK2	2" Kit	4	8	1
PBCVIK2 1/2	2 1/2" Kit	4	8	1
PBCVIK3	3" Kit	4	8	1
PBCVIK4	4" Kit	8	16	1
PBCVIK6	6" Kit	8	16	1
PBCVIK8	8" Kit	8	16	1



PHBFV Series

## Ductile Iron Butterfly Valve Installation Kit Includes:

- One HBFV Series Ductile Iron Butterfly valve.
- Two PF Series PVC Sch 80 Van Stone flanges.
- Bolt kit with steel nuts and bolts.
- Steel washers.
- Rubber gaskets NOT included. (Extended EPDM seat on the HBFV valve acts as gasket seal with flange.)

Part Number	Size	Number of Nuts/Bolts	Number of Washers	Ctn Qty
PHBFV2NG	2" Kit	4	8	1
PHBFV2 1/2NG	2 1/2" Kit	4	8	1
PHBFV3NG	3" Kit	4	8	1
PHBFV4NG	4" Kit	4	8	1
PHBFV6NG	6" Kit	4	8	1
PHBFV8NG	8" Kit	4	8	1 *
PHBFV10NG	10" Kit	4	8	1 *
PHBFV12NG	12" Kit	4	8	1 *

\* Shipped in two cartons





# Clear Braided PVC Hose

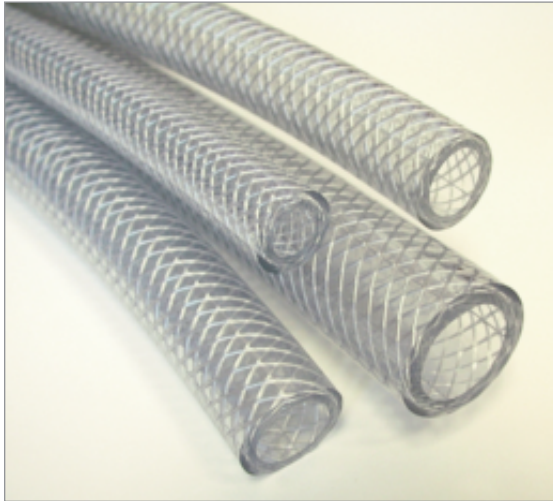

## Clear Braided PVC Hose Standard Wall, Class 125 Features:



- Flexible, see through clear hose with braid pattern reinforcement of two polyester spirals.
- Flexible clear PVC NSF 51 certified to 100°F (38°C), USP CLASS V1 rated.
- All hose compound ingredients used are listed in US FDA CFR, Title 21.
- Temperature range + 25° to 150° F / -5° to +65°C.
- Silicone free.
- Food and beverage grade, standard wall.
- Use for air, water lines.

Part Number	Nominal (inches)		Max Working Pressure		Reel Length	Approx Wt per CFT.
	ID	OD	PSI@68°F	PSI@122°F		
CBH316-1	3/16	0.375	250	105	100'	4.5 lbs
CBH25-1	1/4	0.438	250	105	100'	5.7 lbs
CBH516-1	5/16	0.525	250	105	100'	7.5 lbs
CBH38-1	3/8	0.594	225	97	100'	9.0 lbs
CBH50-1	1/2	0.750	200	86	100'	13.8 lbs
CBH50-3	1/2	0.750	200	86	300'	13.8 lbs
CBH58-1	5/8	0.875	200	86	100'	16.5 lbs
CBH75-1	3/4	1.030	150	65	100'	21.9 lbs
CBH75-3	3/4	1.030	150	65	300'	21.9 lbs
CBH100-1	1	1.300	125	54	100'	31.5 lbs
CBH100-2	1	1.300	125	54	200'	31.5 lbs
CBH125-50	1 1/4	1.625	100	43	50'	45.0 lbs
CBH125-1	1 1/4	1.625	100	43	100'	45.0 lbs
CBH150-50	1 1/2	1.937	100	43	50'	64.0 lbs
CBH150-1	1 1/2	1.937	100	43	100'	64.0 lbs
CBH200-50	2	2.490	75	33	50'	95.0 lbs
CBH200-1	2	2.490	75	33	100'	95.0 lbs

\*\* Temperatures higher than 68° F reduce available working pressure. See next page for temperature, working pressure calculation chart and cautionary note.



**www.cbsupplies.ca**  
 Phone: (866) 503-5523 Fax: (888) 562-2095  
 AGI@cbsupplies.ca



17.020



## Effects of Elevated Temperatures on Thermoplastic Hose.

The compounds used in clear braided PVC hose are generally referred to as thermoplastics. These materials achieve their optimum physical properties at room temperature, 68°F (20°C). As these materials are exposed to increased ambient temperatures, they will soften and their physical properties will change. This will have the effect of sharply reducing the available working pressure. Coupling retention will also be reduced. The charts below illustrate this effect. In all cases, the product should be tested in a controlled, secure and safe environment, and all operating conditions should be considered prior to use.

All published working pressures of AGI Series CBH hose are based on a room temperature of 68°F (20°C).

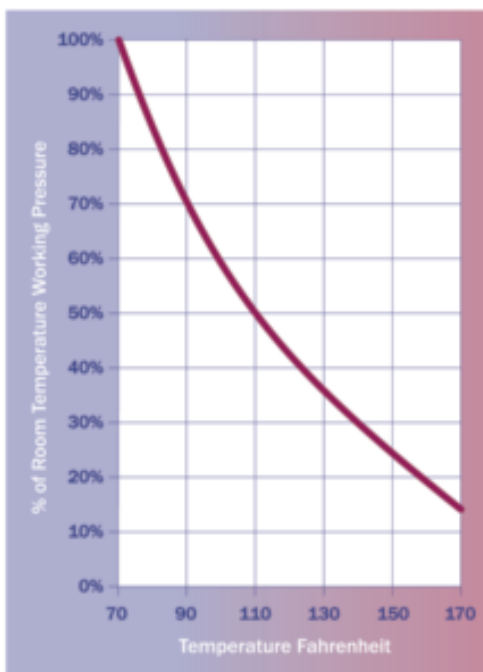

### Example from the Fahrenheit Chart

If working pressure at 68°F is 200 psi, then the WP at 110°F is  $200 \times 50\%$ , or 100 psi

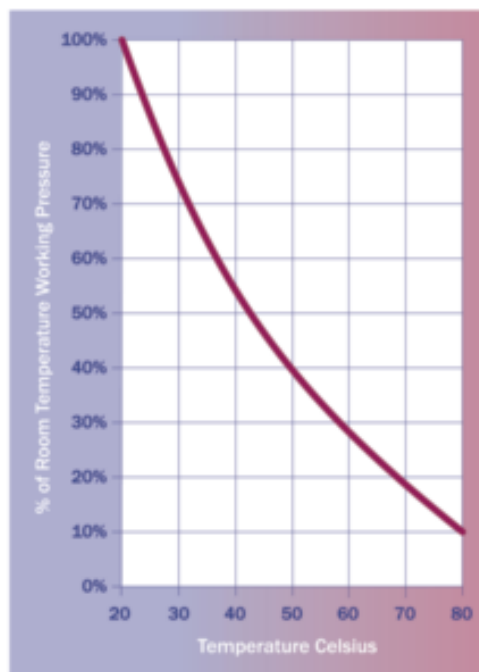

### Example from the Celsius Chart

If working pressure at 20° is 14 bar, then the WP at 50°C is  $14 \times 50\%$ , or 5.6 bar

## CAUTIONARY NOTE

The charts are to be used as a guideline only. The information and recommendations contained here are, to the best of our manufacturer's knowledge, accurate and reliable, but no guarantee of their accuracy is made. All products are sold upon the condition that purchasers shall make their own tests to determine the suitability of such products for their particular purposes and uses, and purchasers assume all risks and liability for the results of use of the products, including use in accordance with seller's recommendations. Variability in length of exposure, temperature, pressure, velocity of fluid, and chemical concentration all contribute to reduced working pressure and hose reliability.



# Tubing - Polyethylene



## Physical Properties of Polyethylene Tubing

Secant Modulus	.3200 PSI
Tensile Strength	1600 PSI
Ultimate Elongation	500%
Water Absorption	0.01%
Density	.912g/cm <sup>3</sup>
Vicat Softening Point	201°F
Melt Index	1.0g/10 min
Thermal Coefficient of Expansion	.11x10 <sup>-5</sup> in/in/°F
Thermal Conductivity	.8x10 <sup>-4</sup> cal/sq cm/sec/°C/cm
Brittleness Temperature	-76°F
Tear Resistance	.475lb/in. of thickness

### Polyethylene Tubing Features:

- Economical.
- Extremely Flexible.
- Translucent.
- Resists Corrosion.
- **NOT FOR USE WITH HOT WATER**

• **SOLD IN COIL LENGTHS ONLY.**

• **ORDER BY THE NUMBER COIL LENGTHS REQUIRED.**

Ex: For 500' of MV4040-5 order Qty 1 MV4040-5

Part Number Bulk Boxed	Part Number Dispenser Box	OD	ID	Wall	Coil Length
MV4040-1BLACK		1/4"	.17"	0.04"	100'
MV4040-1		1/4"	.17"	0.04"	100'
MV4040-5		1/4"	.17"	0.04"	500'
MV4040M		1/4"	.17"	0.04"	1000'
MV4062-1		1/4"	1/8"(.125)	1/16"(.062)	100'
MV4062-5		1/4"	1/8"(.125)	1/16"(.062)	500'
MV4062M		1/4"	1/8"(.125)	1/16"(.062)	1000'
MV5062-1		5/16"	3/16"(.1875)	1/16"(.040)	100'
MV5062-5		5/16"	3/16"(.1875)	1/16"(.062)	500'
MV5062M		5/16"	3/16"(.1875)	1/16"(.062)	1000'
MV6062-1		3/8"	1/4"(.250)	1/16"(.062)	100'
MV6062-5		3/8"	1/4"(.250)	1/16"(.062)	500'
MV6062-5BLACK		3/8"	1/4"(.250)	1/16"(.062)	500'
MV6062M		3/8"	1/4"(.250)	1/16"(.062)	1000'
MV8062-1		1/2"	3/8"(.375)	1/16"(.062)	100'
MV8062-5		1/2"	3/8"(.375)	1/16"(.062)	500'
MV10062-1		5/8"	1/2"(.500)	1/16"(.062)	100'
MV10062-5		5/8"	1/2"(.500)	1/16"(.062)	500'
MV12075-1		3/4"	.6	.075	100'
MV12075-5		3/4"	.6	.075	500'
MV16093-1		1"	.814	.093	100'
	TP308	1/4"	.17"	0.04"	100'
	TP309	5/16"	3/16"(.1875)	1/16"(.040)	100'
	TP310	3/8"	1/4"(.250)	1/16"(.062)	100'
	TP311	1/2"	3/8"(.375)	1/16"(.062)	100'

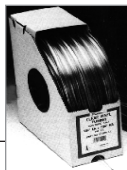

### POLYETHYLENE TUBING SIZING GUIDE



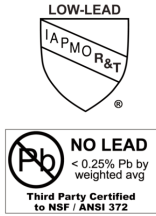

## Physical Properties of Vinyl Tubing

100% Modulus of Elasticity	.800 PSI
Durometer "A"	.68
Tensile Strength	.2000 PSI
Specific Gravity	.1.20
Elongation	.400%
Brittle Temperature	-.40°F
Color	.Crystal Clear
Odor	.Slight
Taste	.None
Toxicity	.Non-Toxic
Aging Characteristics	.Excellent

### Vinyl Tubing Features:

- Flexible.
- Transparent.
- Tasteless.
- Non-Toxic.
- **NOT FOR USE WITH HOT WATER**

### Applications:

- Pool slides
- RV use cold water
- Water softeners
- Ice maker
- Livestock
- Hobby and pet use

• **SOLD IN COIL LENGTHS ONLY.**  
 • **ORDER BY THE NUMBER COIL LENGTHS REQUIRED.**  
 Ex: For 500' of IV7062-5 order Qty 1 IV7062-5

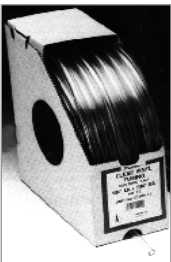
Part Number	Bulk Box	Dispenser Box	OD	ID	Coil Wall	Length
IV4062-1			1/4"	1/8"(.125)	1/16"(.062)	100'
IV5062-1			5/16"	3/16"(.1875)	1/16"(.062)	100'
IV6062-1			3/8"	1/4"(.250)	1/16"(.062)	100'
IV7062-1			7/16"	5/16"(.3125)	1/16"(.062)	100'
IV7062-5			7/16"	5/16"(.3125)	1/16"(.062)	500'
IV8062-1			1/2"	3/8"(.375)	1/16"(.062)	100'
IV8062-5			1/2"	3/8"(.375)	1/16"(.062)	500'
IV8062M			1/2"	3/8"(.375)	1/16"(.062)	1000'
IV10062-1			5/8"	1/2"(.500)	1/16"(.062)	100'
		TV308	1/4"	1/8"(.125)	1/16"(.062)	100'
		TV309	5/16"	3/16"(.1875)	1/16"(.062)	100'
		TV310	3/8"	1/4"(.250)	1/16"(.062)	100'
		TV3105	7/16"	5/16"(.3125)	1/16"(.062)	100'
		TV311	1/2"	3/8"(.375)	1/16"(.062)	100'
		TV3125	5/8"	1/2"(.500)	1/16"(.062)	100'
		TV313-1	7/8"	5/8"	1/8"	100'
		TV314	1"	3/4"	1/8"	50'
		TV315	1 1/4"	1"	1/8"	50'

### VINYL TUBING SIZING GUIDE

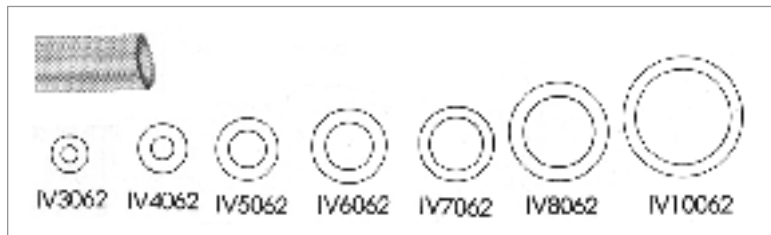



# Fittings for Plastic Tubing - NL Brass



## Barb Fitting Features:

- Superior NO LEAD brass fittings for soft plastic tubing for oil, water, air, vacuum, gas and liquid low pressure lines.
- Exclusive self-clinching double barbs actually tighten under strain.

## Compression Fitting Features:

- NO LEAD Brass compression fittings designed for plastic tubing.
- Built-in tube support prevents tube collapse and allows easy assembly.



VT22

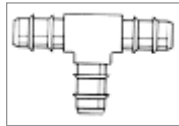

VT224

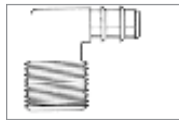

VT229

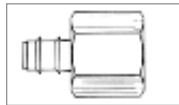

VT26

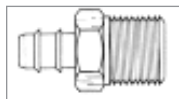

VT28

Part Number	Fits Tube OD	Fits Tube ID	Thread Size	Qty
<b>Coupling (Ins x Ins)</b>				
VT22-4-4NL	3/8"	1/4"		Bulk
VT22-6-6NL	1/2"	3/8"		Bulk
VT22-8-8NL	5/8"	1/2"		Bulk
<b>Tee (Ins x Ins x Ins)</b>				
VT224-4NL	3/8"	1/4"		Bulk
VT224-6NL	1/2"	3/8"		Bulk
<b>Elbow (Ins x MIP)</b>				
VT229-4-4NL	3/8"	1/4"	1/4" mip	Bulk
VT229-6-4NL	1/2"	3/8"	1/4" mip	Bulk
VT229-8-6NL	5/8"	1/2"	3/8" mip	Bulk
<b>Female Adapter (Ins x FIP)</b>				
VT26-4-2NL	3/8"	1/4"	1/8" fip	Bulk
VT26-6-4NL	1/2"	3/8"	1/4" fip	Bulk
<b>Male Adapter (Ins x MIP)</b>				
VT28-4-2NL	3/8"	1/4"	1/8" mip	Bulk
VT28-4-4NL	3/8"	1/4"	1/4" mip	Bulk
VT28-6-4NL	1/2"	3/8"	1/4" mip	Bulk
VT28-8-6NL	5/8"	1/2"	3/8" mip	Bulk



# Fittings for Plastic Tubing - NL Brass



VT62



VT64

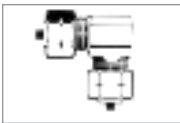

VT65



VT69



VT66



VT68



VT60



VT61

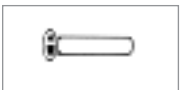

VT63

Part Number	Fits Tube OD	Fits Tube ID	Thread Size	Qty
<b>Union w/ inserts (Comp x Comp)</b>				
VT62-4NL	1/4" x 1/4"	.17"		Bulk
<b>Tee w/ inserts (Comp x Comp x Comp)</b>				
VT64-4NL	1/4" x 1/4" x 1/4"	.17"		Bulk
VT64-6NL	3/8" x 3/8" x 3/8"	1/4"		Bulk
<b>Elbow w/ inserts (Comp x Comp)</b>				
VT65-6NL	3/8" x 3/8"	1/4"		Bulk
VT65-8NL	1/2" x 1/2"	3/8"		Bulk
<b>Male Elbow w/ inserts (Com x MIP)</b>				
VT69-4-4NL	1/4"	.17"	1/4" mip	Bulk
VT69-6-4NL	3/8"	1/4"	3/8" mip	Bulk
<b>Female Connector w/ inserts (Com x FIP)</b>				
VT66-4-4NL	1/4"	.17"	1/4" fip	Bulk
VT66-6-4NL	3/8"	1/4"	1/4" fip	Bulk
VT66-8-8NL	1/2"	3/8"	1/2" fip	Bulk
<b>Male Connector w/ inserts (Comp x MIP)</b>				
VT68-4-4NL	1/4"	.17"	1/4" mip	Bulk
VT68-6-4NL	3/8"	1/4"	1/4" mip	Bulk
<b>Delrin Sleeve</b>				
VT60-4	1/4"			Bulk
VT60-6	3/8"			Bulk
VT60-8NL	1/2"			Bulk
<b>Nut</b>				
VT61-4NL	1/4"			Bulk
VT61-5NL	5/16"			Bulk
VT61-6NL	3/8"			Bulk
<b>Tube Support</b>				
VT63-4NL	1/4"	.17"		Bulk
VT63-6NL	3/8"	1/4"		Bulk
VT63-8NL	1/2"	3/8"		Bulk







# Pipe & Hose Cutters



## HARVARD CONTRACTOR'S Plastic Pipe & Hose Cutter Features:

- Heavy duty, glass reinforced nylon handles.
- Handles designed with matted surface and finger indentation for firm gripping in any weather conditions.
- Handle "bridge" support structure designed to eliminate deflection, bending or breaking while cutting for straighter, truer cut every time.
- "100" and "135" available in black or yellow. "200" available in black.
- Available with either PTFE coated hardened tool steel or polished high-carbon stainless steel blades specially honed to maintain their edge longer than competitive blades.
- Cutter blades individually laser etched with "100", "135" or "200" for easy identification. Replacement blades are blister packed with knock out pin.
- All Harvard Plastic Pipe and Hose cutters are blister packed with an attractive hang-up card.

*The unique cutting action of the Harvard Contractor's cutter is produced by slightly rotating or rocking the cutter on the pipe while squeezing lightly on the handles. After just a few cuts, anyone can make fast, clean, straight cuts. The rotating action is not necessary for rubber hose or soft tubing (except when cutting 2" or larger hose with the SS200).*



T Series



Part Number	Color	Blade Material	Cuts	Ctn Qty	List Price
<b>HARVARD CONTRACTOR Pipe &amp; Hose Cutters</b>					
T100	Black	PTFE Coated Hardened Steel	PE, Rubber hose & PVC (Class & Sch 40) through 1"	50	\$ 21.53
YT100	Yellow	PTFE Coated Hardened Steel	PE, Rubber hose & PVC (Class & Sch 40) through 1"	50	21.53
T100SS	Black	Stainless Steel	PE, Rubber hose & PVC (Class & Sch 40) through 1"	50	22.48
YT100SS	Yellow	Stainless Steel	PE, Rubber hose & PVC (Class & Sch 40) through 1"	50	22.48
T135	Black	PTFE Coated Hardened Steel	PE, Rubber hose through 1 1/2" Class PVC through 1 1/4"	50	24.15
YT135	Yellow	PTFE Coated Hardened Steel	PE, Rubber hose through 1 1/2" Class PVC through 1 1/4"	50	24.15
T135SS	Black	Stainless Steel	PE, Rubber hose through 1 1/2" Class PVC through 1 1/4"	50	25.10
YT135SS	Yellow	Stainless Steel	PE, Rubber hose through 1 1/2" Class PVC through 1 1/4"	50	25.10
SS200	Black	Stainless Steel	Rubber hose through 2" PE through 1 1/2" & Class PVC through 1 1/4"	50	26.61
<b>HARVARD CONTRACTOR Replacement Blades (includes one knock out pin) DP is DOUBLE PACK</b>					
BT100	PTFE Coated Hardened Steel Blade	T100, YT100	100	8.20	
BT100SS	Stainless Steel Blade	T100SS, YT100SS	100	9.16	
BT135	PTFE Coated Hardened Steel Blade	T135, YT135	100	8.98	
BT135DP	PTFE Coated Hardened Steel Blades (2)	T135, YT135	100	17.42	
BT135SS	Stainless Steel Blade	T135SS, YT135SS	100	9.91	
BT135DPSS	Stainless Steel Blades (2)	T135SS, YT135SS	100	19.29	
SSB200	Stainless Steel Blade	SS200	50	10.20	



# Pipe & Hose Cutters



T Series

## HARVARD CONTRACTOR'S Plastic Pipe & Hose Cutter Features:

- Heavy duty, glass reinforced nylon handles.
- Handles designed with matted surface and finger indentation for firm gripping in any weather conditions.
- Handle "bridge" support structure designed to eliminate deflection, bending or breaking while cutting for straighter, truer cut every time.
- "100" and "135" available in black or yellow. "200" available in black.
- Available with either PTFE coated hardened tool steel or polished high-carbon stainless steel blades specially honed to maintain their edge longer than competitive blades.
- Cutter blades individually laser etched with "100", "135" or "200" for easy identification. Replacement blades are blister packed with knock out pin.
- All Harvard Plastic Pipe and Hose cutters are blister packed with an attractive hand-up card.



*The unique cutting action of the Harvard Contractor's cutter is produced by slightly rotating or rocking the cutter on the pipe while squeezing lightly on the handles. After just a few cuts, anyone can make fast, clean, straight cuts. The rotating action is not necessary for rubber hose or soft tubing (except when cutting 2" or larger hose with the SS200).*



Part Number	Color	Blade Material	Cuts	Ctn Qty
<b>HARVARD CONTRACTOR Pipe &amp; Hose Cutters</b>				
T100	Black	PTFE Coated Hardened Steel	PE, Rubber hose & PVC (Class & Sch 40) through 1"	50
YT100	Yellow	PTFE Coated Hardened Steel	PE, Rubber hose & PVC (Class & Sch 40) through 1"	50
T100SS	Black	Stainless Steel	PE, Rubber hose & PVC (Class & Sch 40) through 1"	50
YT100SS	Yellow	Stainless Steel	PE, Rubber hose & PVC (Class & Sch 40) through 1"	50
T135	Black	PTFE Coated Hardened Steel	PE, Rubber hose through 1 1/2" Class PVC through 1 1/4"	50
YT135	Yellow	PTFE Coated Hardened Steel	PE, Rubber hose through 1 1/2" Class PVC through 1 1/4"	50
T135SS	Black	Stainless Steel	PE, Rubber hose through 1 1/2" Class PVC through 1 1/4"	50
YT135SS	Yellow	Stainless Steel	PE, Rubber hose through 1 1/2" Class PVC through 1 1/4"	50
SS200	Black	Stainless Steel	Rubber hose through 2" PE through 1 1/2" & Class PVC through 1 1/4"	50
<b>HARVARD CONTRACTOR Replacement Blades (includes one knock out pin) DP is DOUBLE PACK</b>				
BT100	PTFE Coated Hardened Steel Blade	T100, YT100	100	
BT100SS	Stainless Steel Blade	T100SS, YT100SS	100	
BT135	PTFE Coated Hardened Steel Blade	T135, YT135	100	
BT135DP	PTFE Coated Hardened Steel Blades (2)	T135, YT135	100	
BT135SS	Stainless Steel Blade	T135SS, YT135SS	100	
BT135DPSS	Stainless Steel Blades (2)	T135SS, YT135SS	100	
SSB200	Stainless Steel Blade	SS200	50	



APC100SS

### HARVARD CONTRACTOR'S Plastic Pipe & Hose Cutter with Spring Action Features:

- Heavy duty, cast metal handles.
- Handles designed with matted surface and finger indentation for firm gripping in any weather conditions.
- Spring action for easy use.
- Latch handle for carrying in closed position.
- **Reversible**, replaceable polished high carbon stainless steel blades honed to maintain thin edge longer than competitive blades.
- Cuts PE, Rubber hose & PVC (Class & Sch 40) through 1" ID (max diameter 1 3/8")
- Blister packed with an attractive hang-up card.



The unique cutting action of the Harvard Contractor's cutter is produced by slightly rotating or rocking the cutter on the pipe while squeezing lightly on the handles. After just a few cuts, anyone can make fast, clean, straight cuts. The rotating action is not necessary for rubber hose or soft tubing.



Part Number	Color	Blade Material	Cuts	Ctn Qty
<b>HARVARD CONTRACTOR Pipe &amp; Hose Cutters</b>				
APC100SS	Red	Stainless Steel	PE, Rubber hose & PVC (Class & Sch 40) through 1" ID (max diameter 1 3/8")	50
<b>HARVARD CONTRACTOR Replacement, Reversible Blade</b>				
APC100SSB		Stainless Steel reversible blade		1



CS24L

### HARVARD CONTRACTOR'S PVC Cable Saw Features:

- Multi-purpose cable saw cuts PVC pipe.
- Available in two lengths and two handle styles



CS36T

Part Number	Description	Ctn Qty
<b>Cable Saws</b>		
CS24L	Cable saw, 24" length, Loop handle	50/500
CS36L	Cable saw, 36" length, Loop handle	5/200
CS36T	Cable saw, 36" length, T handle	50



# PVC Pipe Cutters - Ratchet



HRPC42



HRPC50

## HARVARD CONTRACTOR'S PVC Ratchet Pipe Cutter

### Features:

- For use up to 1 1/4" or 2" diameter pipe.
- All stainless steel cutting blade and ratchet teeth.
- All metal body construction with latching handle for safe storage.
- 1 1/4" cutter has quick release thumb lever for easy blade opening.
- 1 1/4" cutter packaged in blister card for easy display.
- 2" two hand cutter has rubber handle grips.
- 2" two hand cutter packaged with wrap around card for easy display.
- Replacement stainless steel blades and spring sets are available.

Part Number	Description	Ctn Qty
<b>Cutters - with stainless steel blade</b>		
HRPC42	PVC Pipe Cutter, 1 1/4"	50
HRPC50	PVC Pipe Cutter, 2"	10
<b>Replacement Blades - stainless steel</b>		
HRPC42B	Blade for HRPC42	1
HRPC50B	Blade for HRPC50	1
<b>Replacement Spring Sets</b>		
HRPC42SP	Spring Set for HRPC42	1
HRPC50SP	Spring Set for HRPC50	1



HS25



HM42



HL48



HL50

## HARVARD® PVC Ratchet Pipe Cutter Features:

- For use on plastic pipes up to 1", 1 1/4", 1 3/8", 1 1/2" or 2" diameter.
- **Blade and ratchet teeth made of molybdenum vanadium stainless steel. Stays sharp longer than plated steel blades.**
- All metal construction insures long life; locking clip provides safe storage.
- Holds pipe as it cuts, creating smooth, even ends.
- One hand operation (except on HL50).

Part Number	Description	Ctn Qty
<b>Cutters - With molybdenum vanadium stainless steel blades</b>		
HS25	PVC Pipe Cutter, 1"	60
HM42	PVC Pipe Cutter, 1-1/4"	60
HL42A	PVC Pipe Cutter, 1 3/8"	60
HL48	PVC Pipe Cutter, 1 1/2"	40
HL50	PVC Pipe Cutter, 2"	20
<b>Replacement Blades - Molybdenum vanadium stainless steel</b>		
HS25B	Blade for HS25	1
HM42B	Blade for HM42	1
HL42AB	Blade for HL42A	1
HL48B	Blade for HL48	1
HL50B	Blade for HL50	1
<b>Replacement Spring Sets</b>		
HS25SP	Spring Set for HS25	1
HM42SP	Spring Set for HM42	1
HL42ASP	Spring Set for HL42A	1
HL48SP	Spring Set for HL48	1
HL50SP	Spring Set for HL50	1





# PVC & ABS Saws and Hacksaws



TBS300

### 14" PVC/ABS Tool Box Saw Features:

- 14" saw for use with PVC or ABS.
- One saw for all applications.
- Cuts wood, aluminum and drain pipe.
- Durable ABS handle.
- Tempered steel blade.
- 15 teeth, 16 points.
- Cuts in both directions.

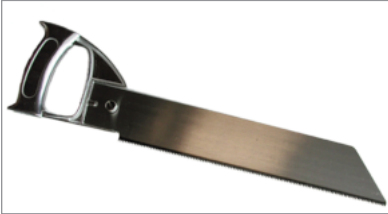

PVCSW

### PVC/ABS Saw Features:

- 12" or 18" saw blade lengths.
- Aluminum die cast handle for sure grip.
- Cuts large diameter PVC or ABS pipe.
- Cuts drywall, paneling, plywood or plaster board.
- Precision milled teeth for faster, cleaner cuts.
- Induction hardened teeth for longer life.
- Cuts in both directions.
- Quick change design allows for changing blades without tools.
- Replacement blades available.

Part Number	Description	Ctn Qty
TBS300	Tool Box Saw, 14" length, 15 teeth, 16 pt.	4/48
PVCSW12	PVC Saw, 12" aluminum handle	12
PVCSW18	PVC Saw, 18" aluminum handle	12
PVCSW12B	PVC Saw 12" BLADE ONLY	12
PVCSW18B	PVC Saw 18" BLADE ONLY	12



T22466

### TASK HIGH TENSION HACKSAWS

#### Task Contractor's High Tension Hacksaw Features:

- Aluminum handle and end piece.
- Square tube frame prevents frame twisting.
- Multiple tension adjustment setting.
- 3 blade positions for 90°, 45° and use as a minisaw.
- Extra blade storage in frame.
- Unconditional warranty.



T22464

#### Task Professional Plus High Tension Hacksaw Features:

- Patented quick change blade feature.
- Soft touch, non-slip grip.
- Square tube frame design prevents frame twisting.
- Multiple tension adjustment settings.
- 3 blade positions for 90°, 45° and use as a mini hacksaw.
- Extra blade storage in frame.
- Unconditional warranty.

Part Number	Description	Ctn Qty
T22466	Contractors Hacksaw	6
T22464	Professional Plus Hacksaw	6



# BOSS Pool & Spa Adhesives, Lubricants & Sealants

BOSS® line of adhesives, grouts and lubricants are specifically formulated for use with pools and whirlpool baths.



### BOSS® 801 Neutral Cure Silicone Adhesive Features:

- A one part, low odor, non-corrosive, oxime cure adhesive and sealant.
- Provides excellent adhesion to ceramic tile, spa jets, skimmers, lighting fixtures, plumbing and fiber optic lighting.
- Adheres well to fiberglass, ABS, acrylic, PVC, wood and masonry.



### BOSS® 802 Acetoxy Cure Silicone General Purpose Adhesive Features:

- A one part, acetoxy cure, adhesive/sealant.
- Performs well in jet sealing applications.
- Designed for many other pool and spa maintenance and repair needs.

### BOSS® 804 Neutral Cure Silicone Ceramic Tile Grout Features:

- A one part, low odor, non-corrosive, oxime cure silicone grout.
- Spreads easily and provides ample tooling time.
- Excellent adhesion to all ceramic tiles.



### BOSS® 820 Pool & Spa Silicone Lubricant Features:

- Water washout resistant and non-solidifying compound.
- Provides superb lubricant for rubber o-rings.
- Non-corrosive, silicone lubricant compound.

### BOSS® 315 RTV 100% Silicone Sealant Features:

- 100% Silicone rubber clear adhesive/sealant.
- Paste-like one component material cures to a tough, rubbery solid when exposed to moisture in the air.
- Can be applied overhead or on walls without sagging.
- Adheres to clean metal, glass, wood, ceramic and painted or plastic surfaces.

Part Number	Description	Ctn Qty
80100B	Silicone Adhesive Clear, 10.3 oz cart	12
80101B	Silicone Adhesive White, 10.3 oz cart	12
80200B	Silicone Adhesive Gen Purpose, Clear 10.3 oz. cart	12
80201B	Silicone Adhesive Gen Purpose, White 10.3 oz cart	12
80131B	Silicone Adhesive Grout, Clear 3 oz. tube	12
80401B	Silicone Ceramic Tile Grout, White 10.3 oz cart	12
82001B	Pool & Spa Lubricant Clear, 1 oz tube bulk	288
82002B	Pool & Spa Lubricant Clear, 1 oz tube 36 pc tub	36
82030B	Pool & Spa Lubricant Clear, 3 oz tube	12
82000B	Pool & Spa Lubricant Clear, 5.3 oz tube	12
31500B	RTV Silicone Seal CLR 10.0 oz tube	12
31580B	RTV Silicone Seal CLR 8 oz pressurized can	12



[www.cbsupplies.ca](http://www.cbsupplies.ca)  
 Phone: (866) 503-5523 Fax: (888) 562-2095  
 AGI@cbsupplies.ca



17.023





# BOSS Expanding Foam Sealant



## BOSS® 333 Expanding Foam Sealant Features:

- Easy to use, multi-purpose urethane foam.
- Unlike ordinary sealants, it expands **three** times it's original volume.
- Adheres to all building materials except PTFE, silicone and polyethelene.
- Seals by expanding into gaps, cracks and crevices.
- Uses including insulating, sealing and filling gaps around pipes, plumbing fixtures, ductwork and foundations.
- UL classified.

## DIRECTIONS FOR USE:

1. Shake can before and during use.
2. Surface must be clean and free of grease and oil.
3. Can must be held UPSIDE DOWN during application.
4. Insert straw into void and depress the trigger. The use of protective gloves is highly recommended.
5. Fill void 50% full to allow for expansion.
6. Uncured foam can be cleaned with acetone or paint thinner.
7. Cured foam can be trimmed, sanded, painted or stained. Foam MUST be painted or covered if application is exposed to UV light.

 <p>R19028 CAULKING AND SEALANTS SURFACE BURNING CHARACTERISTICS APPLIED TO INORGANIC REINFORCED CEMENT BOARD* FLAME SPREAD: 5 SMOKE DEVELOPED: 20 38FN</p> <p>* Tested as applied in three 3/4" beads 5" on center covering 12.5% of the exposed test sample area.</p>
--

Part Number	Description	Ctn Qty
33316B *	Expanding Foam Sealant, 12 oz can w/ application tip	12
33324B *	Expanding Foam Sealant, 24 oz can w/ application tip	12

\* SHIPPING NOTE: Ground shipping only. Can NOT be shipped via air.



# Installation & Repair



## AquaMend®

### AquaMend® Underwater Repair Epoxy

- Ideal for pool & spa repairs.
- Resin and hardener in same stick
- Hand kneadable.
- Unaffected by chlorinated or salt water.
- Sets in 25 minutes, cures in 1 hour.
- Dries off-white.
- Can be sanded and drilled.

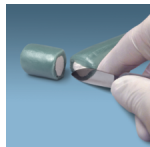

1. Cut



2. Mix



3. Apply

Part Number	Size	Display Ctn Qty
82093	7" stick	12



ISO 9001



### 3M Spray Adhesives

#### BLUE 72

- Repositionable BLUE pressure sensitive spray adhesive.
- One side bonds in 8 hours, aggressive tack, low soak in.
- Covers 100 sq ft.
- Ideal for pool liner installation.

#### ORANGE FOAM FAST 74

- Permanent, light orange, fast tack.
- Two sides bond in 15 minutes.
- Covers 260 sq. ft.

Both manufactured for AGI in an ISO 900 facility.

Pallet pricing available. Call your sales rep.

Part Number	Size	Ctn/Pallet Qty
BLUE 72	Blue Spray Adhesive 24 fl oz can, 17.3 oz net wt.	12/768
ORANGE 74	Orange spray adhesive 24 fl oz can, 17.3 oz net wt.	12/768



HDT Series

## POLYKEN®

### Contractor/Industrial Grade Cloth Reinforced Duct Tape

- Multi-purpose duct tape.
- Polyethylene coated cloth backing.
- Natural rubber based adhesive.
- Temperature range: 40°F to 200 °F.
- Superior tensile strength, adhesion & tack.
- Recommended for pool liner installations.
- Conformable and will not curl or twist during application.
- 10 mil thickness
- Silver
- Manufactured for AGI in an ISO 9002 facility.

ISO 9002

Part Number	Width x Length	Ctn Qty
HDT260	2" x 60 yards	24



FAL32



### Fix A Leak Features:

Fix A Leak is a blended material, designed to seal leaks in just about anything. It works in any kind of pool, spa or hot tub, regardless of constructed material, concrete, fiberglass, acrylic, wood, etc. It works equally well in all plumbing materials including PVC, ABS, poly plastics, vulcathen, copper, steel, etc.

- Seals leaks up to 1/8" in diameter.
- Forms a permanent seal.
- One quart is designed to seal leaks in up to 20,000 gallons. Do not use in excess of 1 quart per 5,000 gallons of water.
- Cures in 24-48 hours.
- Patented by Marlig Industries, Inc.

Part Number	Description	Ctn Qty
FAL32	Fix A Leak Sealant, 32 oz.	12
FAL8	Fix A Leak Sealant, 8 oz.	20

See the "Tapes, Sealants, Cements" and "Permatex Industrial" tabs for more installation & repair materials.



www.cbsupplies.ca  
 Phone: (866) 503-5523 Fax: (888) 562-2095  
 AGI@cbsupplies.ca



17.024



# Installation & Repair



PTC163-6ST

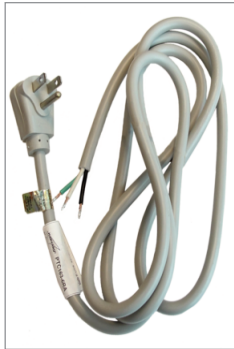

PTC163-6RA

## HARVARD CONTRACTOR'S

### Power Cord Features:

- Three prong straight (115V) or right angle (115V, 220V) molded plugs.
- 16 gauge, 3 conductor, 13 amp, 125 Volt rating.
- 14 gauge, 3 conductor, 15 amp, 250 Volt rating.
- Six foot cord length.
- Free end is split, stripped 3/8".
- UL and CSA listed in US and Canada.



PTC143-6RA220

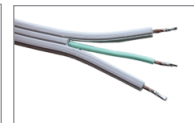

Part Number	Description	Wire Gauge	Volt Rating	Ctn Qty
PTC163-6ST	Straight plug cord	16	125 V	50
PTC163-6RA	Right angle plug cord	16	125 V	50
PTC143-6RA220	Right angle plug cord	14	250 V	50



## HARVARD CONTRACTOR'S

### Anchor Kit Features:

- Anchor kits complete with 100 plastic anchors, 100 screws and 1/4" masonry drill bit in a plastic case.
- Plastic gray ribbed anchors with lip design for electronic timer, pump start relay installations. Use with concrete block, brick and wallboard.
- Anchors have internal ribs for better centering of screws, locking lugs against pull and twist. Exterior design prevents fall out in overhead holes.
- Kit available with combination slotted/phillips head or tri-combination, slotted/phillips/hex head #10 x 1" screws.
- Kits complete with 1/4" x 4" masonry drill bit.
- Clear, unbreakable plastic case with molded-in hanging tab.



Combo Head

Tri Combo Head



Part Number	Description	Ctn Qty
AK10CSPR	Ribbed Combo Head	36
AK10TCR	Ribbed Tri Combo Head	36





# Installation & Repair



2136



LISTED

Swimming Pool,  
Fountain and Spa  
Equipment  
Conductor Splice  
Potting Compound  
2L02

## Scotchcast™ 2136 Wet-Niche Potting Kit Features:

- Provides protection against corrosion and deteriorating effects of pool water by encapsulating the 8 AWG ground connection in a wet niche shell.
- The wet-niche shell is a corrosion-resistant metal housing for underwater fixtures in permanently installed pools.
- Product meets NEC requirements to allow the use of rigid nonmetallic conduit in the installation of wet-niche underwater lighting fixtures.
- Packaged in easy-mix, single use, 1.5 oz. container with cleaning pad, application stick and gloves.
- Will not sag or drip. Gels in minutes and can be submerged within 4 hrs.

Part Number	Description	Ctn Qty
2136	Wet-Niche Potting Kit	10



LR Series



## LR SERIES Features:

- For use with Laars-Raypak pool and spa heaters.
- Stainless steel, with plastic quick connect union



Part Number	Size	Ctn Qty
<b>Stainless Steel Tube with Plastic Quick Connect Union</b>		
LR619-2SSUN	2" X 6" X 19"	6
<b>Union O-Ring</b>		
PHU150 O-RING	1 1/2" o-ring	1
PHU200 O-RING	2" o-ring	1
<b>Heater Union Repair Split Nut</b>		
HSNR150	1 1/2" FBT Heater Split Nut Set w/ screws	125
HSNR200	2" FBT Heater Split Nut Set w/ screws	100



10-417-15

## Hot Water Swimming Pool Heater

### Safety Relief Valve Features:

- Bronze safety relief valve protects ASME Section IV hot water heating boilers and hydronic heating systems.
- High capacity design features corrosion resistant construction.
- Ideal for use in swimming pool heater applications, hot water boilers and hydronic heating systems.
- ASME Section IV.
- Set pressure 75 psi. 20-80 psig certified pressure range.
- Maximum temperature service 250°F
- Stainless steel springs.
- Registered in all Canadian provinces and territories, CRN #0G8547.5C
- Made in USA.

Part Number	Description	Height	Ctn Qty
10-417-15	3/4" M/F Safety relief valve	3"	100





# Repair Fittings for Sch 40 Pipe

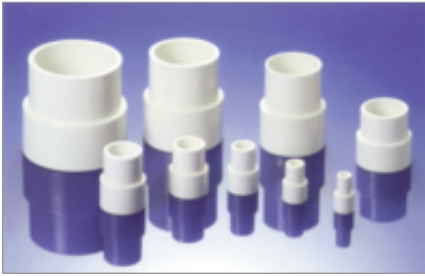

PEX Series



PIC Series

## Pipe Extender and Inside Connector Repair Fitting Features:

- For Sch 40 pipe.
- Saves labor.
- Invisible after installation.
- Permanent repair.
- Insignificant flow restriction.
- PVC Construction.
- PIC Series connects two pieces of Sch 40 pipe with flush joint.

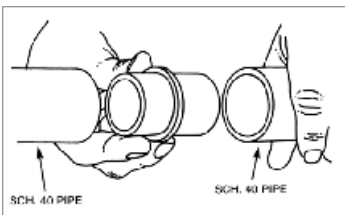
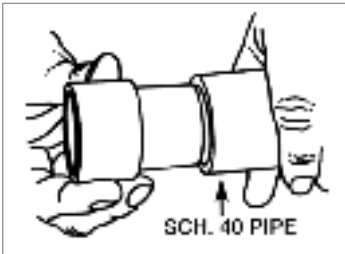

Part Number	Description	IPS Size	Ctn Qty
<b>Pipe Extender Repair Fitting</b>			
PEX50	Pipe Extender	1/2"	48
PEX75	Pipe Extender	3/4"	48
PEX100	Pipe Extender	1"	48
PEX125	Pipe Extender	1 1/4"	48
PEX150	Pipe Extender	1 1/2"	48
PEX200	Pipe Extender	2"	48
PEX250	Pipe Extender	2 1/2"	96
PEX300	Pipe Extender	3"	96
PEX400	Pipe Extender	4"	48
<b>Inside Connector Repair Fitting</b>			
PIC100	Inside Connector	1"	48
PIC150	Inside Connector	1 1/2"	48
PIC200	Inside Connector	2"	48





# Concrete Repair



*A simple squeeze to repair horizontal cracks and spalls, and to set anchors*

DP600

## Horizontal Concrete Repair Features:

*Hardens in as little as 5 minutes,*

Cracks and spalls in concrete floors are an eyesore as well as a potential safety risk. Fixing them has meant either hiring and waiting for an outside contractor or doing it yourself with a repair method that takes the floor out of service for up to 24 hours. Now with 3M Concrete Repair, you save money and time.

- Self-leveling urethane flows smoothly into cleaned cracks and gaps and hardens in as little as 5 minutes. A fork lift can pass over a repair in as few as 15 minutes.
- Hardens to any depth without cracking or shrinking.
- Flexible urethane expands and contracts for durability that outlasts repairs made with concrete.
- Do it yourself with a common caulking gun and eliminate the cost and wait for an outside contractor.
- *Easy to use - Just clean damaged area and fill. With every squeeze of the caulking gun trigger, cartridge nozzle meters and mixes precise proportions for optimum performance.*



Part Number	Description	Ctn Qty
DP600	Concrete Repair, 8.4 fl oz cartridge supplied with 2 nozzles	6



9" Ratchet Style Caulking Gun

Part Number	Size	Color	Ctn Qty
CG9	9" Ratchet	Blue	20







# Concrete Repair



## Horizontal Concrete Repair Specifications:

- Gray, self-leveling urethane concrete repair.
- 8.4 fl oz. cartridge of concrete repair and 2 nozzles.
- Work life of 70 sec.
- Handling time of 5 minutes
- Cure time of 60 minutes

### Applications:

- Repairing cracks and spalls on concrete floors or horizontal surfaces.
- Setting anchors in concrete floors or horizontal surfaces.
- Light-duty custom threading and anchoring.
- Use outdoors or in highly ventilated area.

### Approximate coverage:

Crack Width	Crack Depth	Lineat Feet per 8.4 fl. oz.
1/4"	1/4"	19.3
1/2"	1/4"	9.9
3/4"	1/4"	6.4
1"	1/4"	4.9
1/4"	1/2"	9.9
1/2"	1/2"	4.9
3/4"	1/2"	3.0
1"	1/2"	2.0

Bead Size dimension	Linear Feet per 8.4 fl oz.
1/16"	815.0
1/8"	205.0
1/4"	51.9
3/8"	22.2
1/2"	12.4

## Quick and Easy Spall Repair



**Clean**  
Remove all loose material from area to be filled. Concrete should be dry and grease-free.



**Fill**  
Dispense product into deepest part of repair areas, slightly overfilling. Product self-levels and is tack-free in as little as one minute.



**Finish**  
In as little as 15 minutes, product can be sanded to remove rough edges. It can be painted within one hour.



# Equipment Pads

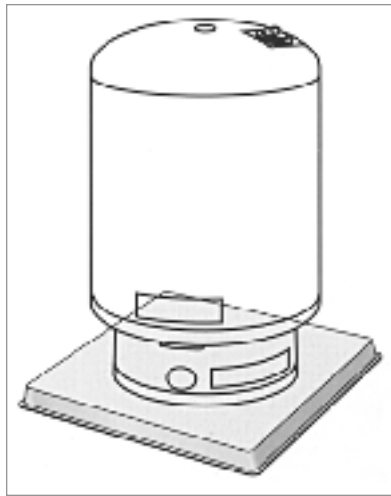

### HEF-T-PAD™ Features:

- Injection molded from high impact polyolefin for strength and durability.
- Resistant to impact, UV degradation and weathering.
- Will not crack, flake or warp.
- Virtually impervious to climate changes.
- Drillable, permits installation of refrigerant and electrical lines under and through pad. Also permits equipment to be easily secured to pad.
- Unique, non-creep surface absorbs vibration and noise and keeps equipment in it's original position.
- Gray

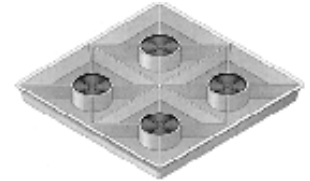

Underside of Hef-T-Pad showing support ribs, stabilization pads and stabilization flange.

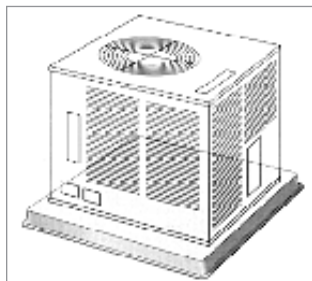
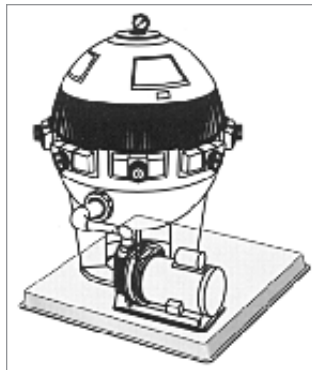

Part Number	Size	Pallet Qty
<b>2" HEF-T-PADS</b>		
X2424211	24" x 24" x 2" one piece	24
X2430211	24" x 30" x 2" one piece	24
X2436211	24" x 36" x 2" one piece	24
X3232211	32" x 32" x 2" one piece	24
X3244211	32" x 44" x 2" one piece	24
X3636211	36" x 36" x 2" one piece	24
X3830211	38" x 30" x 2" one piece	24
X3836211	38" x 36" x 2" one piece	24
X3842211	38" x 42" x 2" one piece	24
<b>3" HEF-T-PADS</b>		
X2424311	24" x 24" x 3" one piece	16
X2436311	24" x 36" x 3" one piece	16
X3030311	30" x 30" x 3" one piece	16
X3232311	32" x 32" x 3" one piece	16
X3636311	36" x 36" x 3" one piece	16
X3848311	38" x 48" x 3" one piece	16
X5055301	50" x 55" x 3" one piece	16



# Pool Service Accessories

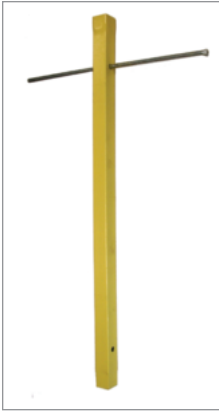

SPPW405

### 2 in 1 Swimming Pool Plug Wrench Features:

- Fits 1 1/2" or 2" cleanout plugs.
- 31" long.
- Removable 18" plated steel handle.
- Heavy duty, powder coated steel to resist rust and corrosion.
- No welds to corrode.

Part Number	Description	Ctn Qty
SPPW405	1 1/2" / 2" pool plug wrench with handle	24
SPPW405H	Replacement handle only for SPPW405	250

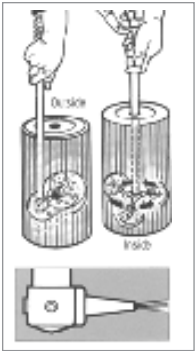

MBC75

### Master Blaster Cleaner Features:

- 3/4" FGHT connection.
- Handy on/off lever.
- For general pool/spa cleanup of filters, under copings.

Part Number	Description	Size	Ctn Qty
MBC75	Master Blaster Cleaner	3/4"	12

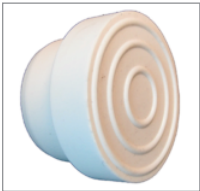

AGLFB19

### Ladder Bumper Features:

- White, molded EPDM.

Part Number	Description	Fits Tubes	Ctn Qty
AGLFB19	Male Ladder bumper	1.9" OD	200

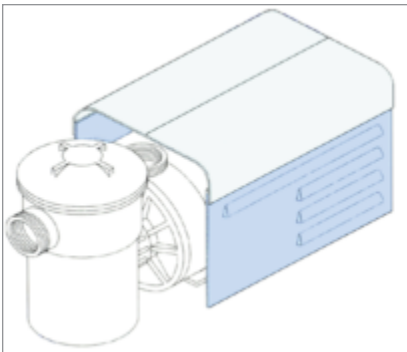

B8200C

### Universal Motor Cover Features:

- Fits all motors from 1/3 hp to 2 hp.
- Shields and protects outdoor motors from sun, rain and dust.
- Made of heavy duty plastic for long life and durability.
- Heat resistant white top and attractive blue sides.
- Sturdy, will not fade from sun or ultraviolet rays.
- Assembles in minutes. No tools needed.

Part Number	Description	Ctn Qty
B8200C	Universal Motor Cover	12



# Pool Service Tools - Multipurpose Tools



MW, CWMP, RPNH

## Wingmaster® Plus Tool Features:

- The all in one **patented** tool for pool technicians.
- **Original** Wingmaster® Plus includes 7" cylinder, hex bar and hand knob.
- 5" Mini tool fits in tight spots such as main drains and skimmers.
- Nylon holster available separately.
- **US Patent #6,374,708**

## Typical Applications



Tighten/loosen winterizing and pressure testing plugs



Remove plugs from pipe using threaded end tool or adapter



Install/remove slotted plugs



Install/remove flush plugs



Raise/lower safety cover anchors (1/4" and 3/16" hex)



Hold plugs in place for vacuuming

Part Number	Description	Ctn Qty
CWMP	Wingmaster Plus Tool 7"	1
MW	Mini Wingmaster Plus Tool 5"	1
RPNH	Nylon Holster for CWMP/MW	1



PTM

Wingmaster® is an American Granby Inc. registered trademark.

## Wingmaster® Plus PT Master Tool Features:

- Tighten, loosen Anderson pressure testing plugs.
- Has 1/8-27, 5/16-18, 1/2-13 and 5/8-11 fitting ends.
- Supplied with open end wrench.



Remove test plugs using the threaded end tool adapter.



Releases air from tire valve plug.



Tighten/loosen air hoses.

Part Number	Description	Ctn Qty
PTM	PT Wingmaster Plus Tool 5" w/ wrench	1



# Pool Service Tools - Anchor, Shell Extractor Kits



## Wingmaster® Anchor Extractor Features:

- Removes old cover anchors including anchors with escutcheons with the special design feature of the anchor extractor.
- Anchor Extractor available only in NANSK or NANSK2 kit.

To remove safety cover anchors:



1. Thread anchor with tap



2. Turn stud in anchor



3. Place extractor over stud

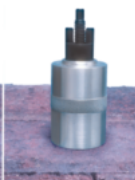

4. Thread castle nut onto extractor.



5. Attach tool. Turn clockwise to remove anchor.



6. Place square tip of stud into tool to remove old anchor from extractor.



Part Number	Description	Ctn Qty
JS	Hardened Stud (For 10-15 pulls)	1
CN	Castle Nut	1



KEMB

## KEMB - Wingmaster® Castle Nut Driver Features:

- Tightens and loosens Castle Nut (CN) with the use of a cordless screw gun.
- Used in the removal of safety cover anchors with the NANSK Kit.
- Works with 5/16 Tap for the tapping (threading) of cover anchors.

Part Number	Description	Ctn Qty
KEMB	Castle Nut Driver	1



NANSE

## Wingmaster® Shell Extractor Kit Features:

- Removes brass anchor shells - pop-up or threaded style.
- Includes SEW wrench, 11/16 tap and shell adapter.
- Wrench and tap available separately.
- Shell Adapter available only with NANSE kit.



1. Insert tap in pop-up shell to create threads (For threaded shell proceed to 2)



2. Thread adapter into shell



3. Thread stud in adapter 1/4"



4. Place tool on castle nut and turn clockwise to remove anchor

Part Number	Description	Ctn Qty
NANSE	Shell Extractor Kit	1
SEW	Shell Extractor Wrench	1
TAP1116	Tap 11/16	1

Wingmaster® is an American Granby Inc. registered trademark.



www.cbsupplies.ca  
 Phone: (866) 503-5523 Fax: (888) 562-2095  
 AGI@cbsupplies.ca







# Pool Service Tools - Multipurpose Keys

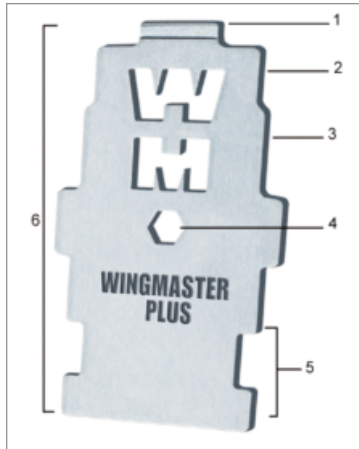

WK

## Wingmaster® Key Features:

- Multipurpose, stainless steel service tool.
1. Screwdriver.
  2. Install/remove 3-way Hayward valve unions.
  3. Install/remove directional fittings.
  4. Use hex bar through center hole for more turning and torque.
  5. Install/remove universal wall fittings.
  6. Install/remove Waterway Poly Jet series face ring.



1. Screwdriver to raise/lower slotted anchors.



2. Install/remove 3-way Hayward valve unions



3. Install/remove directional wall fittings



4-5. Install/remove universal wall fittings. Place hex bar in hole for more turning and torque.

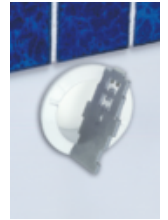

6. install/remove Waterway Poly Jet series face ring.

Part Number	Description	Ctn Qty
WK	Wing Key	1

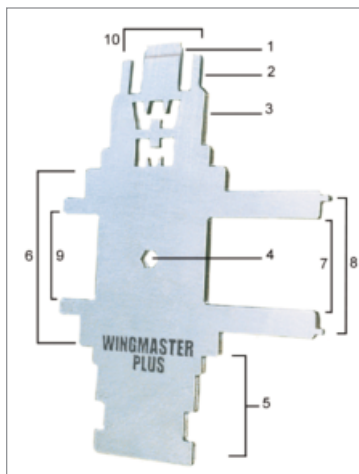

WKJ

## Wingmaster® Jet Key Features:

- Multipurpose, stainless steel service tool.
1. Screwdriver.
  2. Install/remove 3-way Hayward valve unions.
  3. Install/remove directional fittings.
  4. Use hex bar through center hole for more turning and torque.
  5. Install/remove Polaris/Letro universal wall fittings.
  6. Install/remove Waterway Poly Jet face rings.
  - 7-8. Install/remove Hayward jet nozzle retaining rings or broken ring tips.
  9. Install/remove Hydro-Air spa jet face ring.
  10. Install/remove Hydro-Air (Slim-line) face ring.



7. Install/remove Hayward jet nozzle retaining ring.

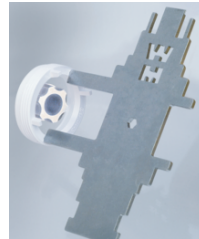

8. Install/remove broken Hayward retaining ring tips.



9. Install/remove Hydro-Air spa jet face ring



10. Install/remove Hydro-Air Slimline face ring.

Part Number	Description	Ctn Qty
WKJ	Jet Key	1

Wingmaster® is an American Granby Inc. registered trademark.



www.cbsupplies.ca  
 Phone: (866) 503-5523 Fax: (888) 562-2095  
 AGI@cbsupplies.ca







# Pool Service Tools - Service Kits



NANSK

## Wingmaster® Plus Service Kit Features:

7" Multipurpose Wingmaster Plus tool, Anchor Extractor, Wing Key and carrying case.

### Includes:

- Hand knob, cylinder, hex bar
- Anchor extractor, castle nut, hardened stud
- Anchor extractor for anchors with escutcheons (NANSK2 only).
- Wing key
- 12/24 tap
- 5/16 tap
- Molded Carrying case
- Wingmaster® Plus Tool. US Patent # 6,374,708

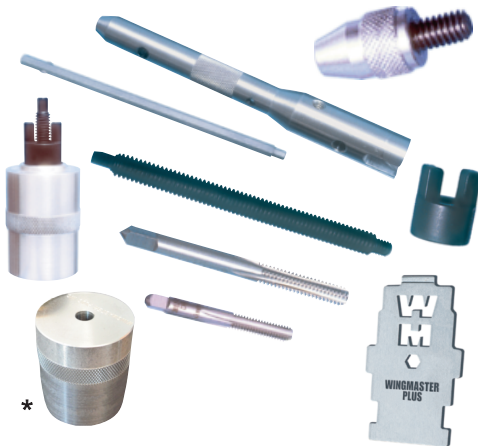

Part Number	Description	Ctn Qty
NANSK	Wingmaster Plus Service Kit	1
NANSK2*	Wingmaster Plus Service Kit	1
MHK	Hand Knob	1
MHB	Hex Bar	1
JS	Hardened Stud (For 10-15 pulls)	1
CN	Castle Nut	1
TAP1224	Tap 12-24	1
TAP516	Tap 5-16	1
BMC	Blow Molded Case	1

\* Includes anchor extractor for removal of anchors with escutcheons.



KAAK

## Wingmaster® Plus Multipurpose Accessory Kit

### Features:

- Wrenches for multiple applications, packed in molded and padded case.

### Includes:

- Caretaker Wrench
- Recessed Square Plug Wrench
- "X" Plug Wrench (JoSam)
- Jet Nozzle Wrench
- Square Plug Wrench
- Stretch Master
- Slotted Wrench for 1022 raised bar plug
- Mini Wingmaster® Plus Tool. US Patent # 6,374,708



CTW

RSW

XPLUG

MW

SQW

SPW

SM

Part Number	Description	Ctn Qty
KAAK	Multipurpose Accessory Kit	1
CTW	Caretaker Wrench	1
RSW	Recessed Square Plug Wrench	1
XPLUG	X Plug (JoSam)	1
SQW	Square Plug Wrench	1
SM	Stretch Master	1
SPW	Slotted Plug Wrench	1
MW	Mini Wingmaster Tool 5"	1

Wingmaster® is an American Granby Inc. registered trademark.



[www.cbsupplies.ca](http://www.cbsupplies.ca)  
 Phone: (866) 503-5523 Fax: (888) 562-2095  
 AGI@cbsupplies.ca





# Pool Service Tools - Accessories



WB

### Wingmaster® Bar Features:

- Raise or lower cover anchors from a standing position.
- Fits 1/4" and 3/16" anchors.
- Overall bar length is 32".



Part Number	Description	Ctn Qty
WB	Bar	1



OTWAB

### Wingmaster® Wing Bit Features:

- Countersinks wood anchor flush to deck.
- Simple, fast and flush every time.
- Comes with 1 1/2" blade.
- 2" blade (Meyco) available.
- US Patent # 7,264,427



Part Number	Description	Ctn Qty
OTWAB	Wing Bit w/ 1 1/2" blade	1
OTRB1.5	Replacement Blade 1 1/2"	1
OTRB2	Replacement Blade 2"	1



HRVS

### Wingmaster® Hydrostatic Tool Features:

- Install or remove hydrostatic relief valves in main drain or Sylvan "X" plug (JoSam) and floor return cap.



Remove/install Hayward hydrostatic relief valve in main drain

Install/remove Sylvan floor return cap and "X" plug (JoSam)

Part Number	Description	Ctn Qty
HRVS	Hydrostatic Tool	1

Wingmaster® is an American Granby Inc. registered trademark.





# Pool Service Tools - Accessories



SCRT

## Wingmaster® Easy Lift™ Spring Cover Removal Tool Features:

- Quick and easy installation and removal of cover springs with T-handle and quick spring grip.
- Stainless Steel T handle allows for greater leverage. Includes 1/4" and 3/16" stainless steel Allen wrenches to raise/lower anchors.



Part Number	Description	Ctn Qty
SCRT	Spring Cover Removal Tool	1



AEMBW

## Wingmaster® Skimmer Guard Blowout Wrench Features:

- Tightens and loosens skimmer guards.
- Works on Harvard, Gizzmo and Eddie Blowout.

Part Number	Description	Ctn Qty
AEMBW	Skimmer Guard Blowout Wrench	1



LAW

## Wingmaster® Anchor Socket Washer Features:

- Contoured washer to fit handrail and ladder anchor sockets.
- Fits up to 3/8" bolt.
- Insures a tight fit for safety.
- Allows bolt to have flush fit and wider coverage around anchor socket.
- Completes pool bonding.

Part Number	Description	Ctn Qty
LAW25	Anchor Socket Washers, 25 pack	1

Wingmaster® is an American Granby Inc. registered trademark.



**www.cbsupplies.ca**  
 Phone: (866) 503-5523 Fax: (888) 562-2095  
 AGI@cbsupplies.ca





# Pool Service Tools - Accessories



WMSK

### Wingmaster® Stencil Kit Includes:

- High quality stencils made of stainless steel.
- Numbers: 0,1,2,3,4,5,6,7,8,9, 1/2
- Letters for FEET, INCH, DEEP.
- NO DIVING symbol and words
- 2" high letters for FEET DEEP, INCHES DEEP.
- 3 top over spray panels.
- Molded storage case included.

Part Number	Description	Ctn Qty
WMSK4	Wing Stencil Kit, 4" high	1
WMSK5	Wing Stencil Kit, 5" high	1

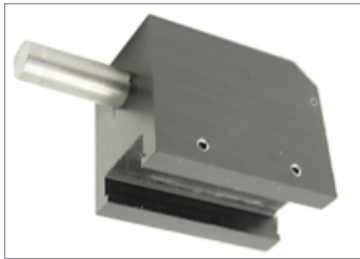

SLH

### Wingmaster® Snap-In Level Holder Features:

- Use with a torpedo level.
- Spring loaded to fit and ensure level installation of 1 1/2" and 2" fittings.
- Clamps to torpedo level.
- Snaps into fitting.

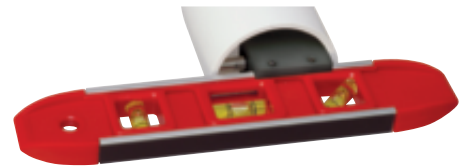

Part Number	Description	Ctn Qty
SLH	Snap In Level Holder	1



PDT

### Wingmaster® Pipe Deburr Features:

- Removes PVC burrs from inside and outside of all size pipe.
- Cleans out pump impellers.
- Replacement blades available.



Part Number	Description	Ctn Qty
PDT	Pipe Deburr Tool	1
PDRB	Pipe Deburr Replacement Blade	1

Wingmaster® is an American Granby Inc. registered trademark.



[www.cb-supplies.ca](http://www.cb-supplies.ca)  
 Phone: (866) 503-5523 Fax: (888) 562-2095  
 AGI@cbsupplies.ca





# Pool Service Tools - Accessories



MH

### Wingmaster® Multi-Handle Features:

- Attaches to many pool maintenance tools to shorten poles for easier use in spas and tight spaces.
- Two holes to accept delcron spring clips.
- Plastic handle cover for sure grip.
- Use with skimmer nets, wall brushes and pumice stones.
- Use with 4" and 8" algae brushes for cleaning heat exchangers.



Part Number	Description	Ctn Qty
MH	Multi Handle	1



BC

### Wingmaster® Burner Cleaner Features:

- Blow-through tube for hookup to compressed air.
- Textured (knurled) and curved end to grab spider webs.
- Easy access to accumulated debris in heater orifices.
- Works on Pentair, Zodiac and Hayward heaters.

Part Number	Description	Ctn Qty
BC	Burner Cleaner	1



DSSB

### Wingmaster® Drain Screw Security Bit Features:

- Tighten and loosen uni-screw for drain safe lids.

Part Number	Description	Ctn Qty
DSSB	Drain Screw Security Bit	1

Wingmaster® is an American Granby Inc. registered trademark.



[www.cbsupplies.ca](http://www.cbsupplies.ca)  
 Phone: (866) 503-5523 Fax: (888) 562-2095  
 AGI@cbsupplies.ca





# Winterizing Plugs



HWP Flush Plug



HWP Raised Plug



HWP Rubber Plug



## Winterizing Plug Applications:

- Safely seals swimming pool inlets and outlets against freezing.
- Temporary pluggings of any water system application for either pipe or fitting sizes.

## Plastic 1-1/2" Threaded Plug Features:

- Heavy duty, white ABS construction.
- EPDM o-ring is resistant to extreme weather & chemical corrosion.
- Gives a positive seal - no leaking.
- Available in raised or flush style.

## Rubber Expansion Plug Features:

- Stainless steel screw and washers.
- Nylon wing nut provides easier turning in cold temperatures, providing greater tightness than conventional plugs.
- Tapered.

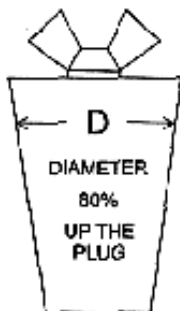
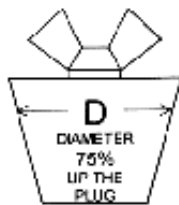

Part Number	D (in)	Plug Size	Used For	Case/Ctn Qty
<b>Plastic</b>				
HWP1022B(Flush)	1-1/2"	White	1 1/2" fip	1000/50
HWP1022C(Raised)	1-1/2"	White	1 1/2" fip	1000/50
<b>Rubber</b>				
HWP2000	0.46	000	3/8" pipe	500/50
HWP200	0.63	0	1/2" pipe	500/50
HWP201	0.70	1	1/2" pipe	500/50
HWP202	0.75	2	3/4" tube	500/50
HWP203	0.89	3	3/4" pipe	500/50
HWP204	0.96	4	3/4" & 1" pipe	500/50
HWP205	1.02	5	1" tube	500/50
HWP2055	1.06	5 1/2	1" pipe	500/50
HWP206	1.20	6	1" fitting	500/50
HWP2065	1.27	6 1/2	1 1/4" pipe	200/20
HWP207	1.39	7	1 1/4" pipe	200/20
HWP2075	1.46	7 1/2	1 1/2" pipe	200/20
HWP208	1.54	8	1 1/2" pipe	200/20
HWP2085	1.62	8 1/2	1 1/2" pipe	200/20
HWP209	1.69	9	1 1/2" pipe & 1 1/4" ftg	200/20
HWP2095	1.73	9 1/2	1 1/2" fitting	200/20
HWP20975	1.81	9 3/4	1 1/2" fitting (for SP1023G)	200/20
HWP210	1.89	10	1 1/2" fitting	60/10
HWP211	2.13	11	2" pipe	60/10
HWP212	2.42	12	2" fitting	60/10
HWP213	2.58	13	2 1/2" pipe	30/5
HWP2135	2.82	13 1/2	3" pipe	40/5
HWP214	3.40	14	3" pipe	30/5
HWP215	3.86	15	4" pipe	30/5
HWP216	4.64	16	4" pipe	20/4
HWP1-5	1.02	01-05	Universal tapered 01-05	250/50
HWP5-7	1.36	05-07	Universal tapered 05-07	100/20
HWP7-10	1.78	07-10	Universal tapered 07-10	100/20





SKG Series

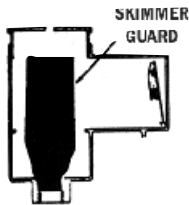

## Winterizing accessories for pool closings



### SKG Skimmer Guard Features:

- Installs in skimmer to prevent freezing and breakage.
- Ends are threaded for 1 1/2" and 2" applications.
- SKG-H with blowout hole, o-ring seals to allow skimmer lines to be blown out without dropping water level.
- SKG9H fits SP1090 series skimmers.
- SKG16H fits SP1070 and SP1080 series skimmers.

### Water Tube and Air Pillow Features:

- Single and double tubes available.
- Double chambers extend life of water tubes.
- 12 and 20 mil thickness on tubes. 12 mil on pillows.
- Used for weighing down winter covers on inground pools.



DCWT Series



AP44

Part Number	Description	Color	Ctn Qty
<b>Skimmer Guards</b>			
SKG9	9" Skimmer guard	Teal-Green	36
SKG9H	9" Skimmer guard w/ blowout hole	Teal-Green	36
SKG16	16" Skimmer guard	Teal-Green	24
SKG16H	16" Skimmer guard w/ blowout hole	Teal-Green	24
<b>Water Tubes</b>			
SCWT8	8' Single chamber, 12 mil	Blue	36
SCWT8-20	8' Single chamber, 20 mil	Blue	24
SCWT10	10' Single chamber, 12 mil	Blue	30
DCWT8	8' Double chamber, 12 mil	Blue	36
DCWT10	10' Double chamber, 12 mil	Blue	30
DCWT8-20	8' Double chamber, 20 mil	Blue	24
DCWT10-20	10' Double chamber, 20 mil	Blue	24
<b>Air Pillows</b>			
AP44	4' x 4' Air pillow, 12 mil	Blue	24
AP48	4' x 8' Air pillow, 12 mil	Blue	12



CCP300

### Pool Cover Pump Features:

- Magnetic drive motor - Only one moving part.
- Completely submersible.
- Easily hooks up to any standard 3/4" garden hose.
- Extra-long 25' power cord with grounded plug.
- Sturdy ceramic shaft impeller.
- Includes easy clean clog resistant foam filter.
- 1 year warranty.
- Listed to UL and cUL standards.



CCP350 / CCP500

Part Number	Description	Max Output	Max Pump Height	Ctn Qty
CCP300	Pool Cover Pump	300 gph	6'	18
CCP350	Pool Cover Pump	350 gph	7'	6
CCP500	Pool Cover Pump	500 gph	10.5'	6



91025 & 91330

### Submersible Utility Pump Features:

- 1/5 & 1/3 HP motors, 120 v, 60 Hz
- Corrosion resistant construction.
- 10' waterproof power cord.
- Clog resistant open type impeller.
- Fits in 6" opening.
- Capacities of 26 & 40 gpm.
- 1 year limited warranty.



### Specifications:

Discharge: 1 1/4" MNPT or 3/4" GHT  
 Housing & Base: Thermoplastic  
 Impeller: Non-clogging open type  
 Bearing: Permanently lubricating  
 Motors: Permanent split capacitor, continuous duty, thermally protected



92250 & 92330

### Submersible Sump Pump Features:

- 1/4 & 1/3 HP motors, 120 v, 60 Hz
- Corrosion resistant construction.
- 10' waterproof power cord.
- Clog resistant open type impeller.
- Switch turns on at 9", off at 4".
- Handles 1/8" solids.
- 1 year limited warranty.



### Specifications:

Discharge: 1 1/4" MNPT  
 Housing & Base: Thermoplastic  
 Impeller: Non-clogging open type  
 Bearing: Permanently lubricating  
 Motors: Permanent split capacitor, continuous duty, thermally protected

Model No.	HP	Gallons per minute at discharge height in feet						Min. Lift	Min. Amps
		0'	5'	10'	15'	20'	25'		
SP91025	1/5	26	21	14	10	7	1	25'	3.6
SP91330	1/3	40	34	28	22	12	2	25'	4.1
SP92250	1/4	30	22	20	16	9	2	25'	3.8
SP92330	1/3	40	34	28	22	12	2	25'	4.1

Note: Use of smaller diameter pipe, or long runs of pipe, will result in lower flow rates than those shown.